



NORANDEX
MAXIMA[®]
ENTRY DOORS





NORANDEX
MAXIMA[®]
Advantage

First impressions are the most lasting, that's why MAXIMA[®] Entry Doors by Norandex are thoughtfully designed with enhanced details customizable to fit your style. With MAXIMA you can find the freedom in design to create the perfect entryway. Not only are MAXIMA doors beautiful, but they are designed with the homeowners top qualities in mind.



SURROUNDED BY QUALITY

We build entry door systems using carefully selected components and quality workmanship.



BUILT FOR LONG-TERM PERFORMANCE

Our entry doors are built to perform in all climates.



KEEP YOUR FAMILY SAFE

We build our doors with security at the forefront to ensure that what's most important to you is protected in your home.



SELECTION FOR EVERY STYLE

Your front door is the first thing guests see when they enter your home. We create entrance systems that reflect your individual style.

Table of Contents

Sometimes the smallest details leave the most lasting impressions.
Let us help you create your dream entryway leaving no detail forgotten.
Create an entry that accentuates your personal style.



BARCELLO
page 108



BLANCA
page 70



BLINDS
page 66



BROWNSTONE
page 106

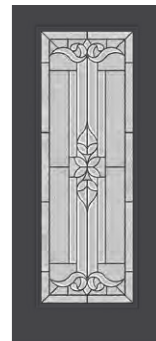

CANTEBERRY
page 128



CHINCHILLA
page 72



HARRISON
page 130

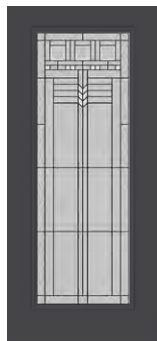

HEARTLAND
page 102



**INTERNAL GRILLES
ARTS & CRAFTS**
page 54



**INTERNAL GRILLES
COLONIAL**
page 52



**INTERNAL GRILLES
PRAIRIE**
page 51



LINEN
page 82

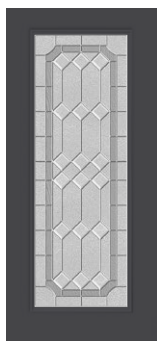

OXFORD
page 132

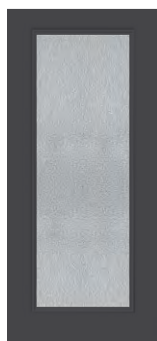

RAIN
page 86



REGENCY
page 134



**SIMULATED
DIVIDED LITES**
page 56



STREAMED
page 90



TOPAZ
page 96

NEW PRODUCTS..... 6-7

DISCOVER YOUR STYLE8-17

CURB APPEAL.....18

DESIGN YOUR DREAM ENTRY19

BUILT WITH SECURITY..... 20-21

QUALITY & PERFORMANCE.....22-23

DOOR SERIES.....24-25

WestGuard Doors & Commercial Capabilities.....26-27

Cambridge Smooth Steel Doors28-29

Valueline Steel Doors..... 30

Norwood Textured Steel Doors 31

Trugrain™ Steel Doors 32-33

Timberline Fiberglass Doors..... 34-35

Timbergrain Fiberglass Doors.....36-37

Heritage Wood Doors..... 38-39

GLASS COLLECTIONS..... 40-41

Clear Glass..... 42-47

Grilles & Divided Lites.....48-49

Vented Glass..... 65

Enclosed Blinds66-67

Privacy Collection.....68-69

Craftsman Collection..... 94-95

Urban Collection 104-105

Modern Collection.....114-115

Rustic Collection..... 120-121

Traditional Collection.....126-127

INNOVATIONS DIGITAL DESIGNS 136

4/0 WIDE DOOR137

FRAME OPTIONS..... 138-139

HARDWARE OPTIONS.....140-141

DISCOVER YOUR COLOR 142-147

SWING OPTIONS.....148-150

OPENING SPECIFICATIONS..... 151



CLEAR
page 42

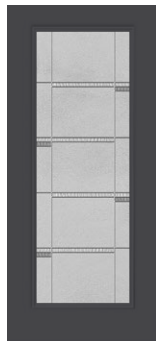

CROSSWALK
page 118

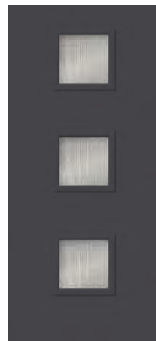

CUBED
page 76



CUMULUS
page 78



FROSTED
page 80



GLACIER
page 116

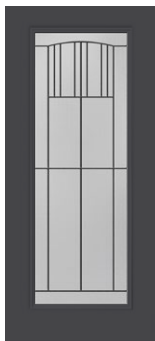

MADISON
page 98

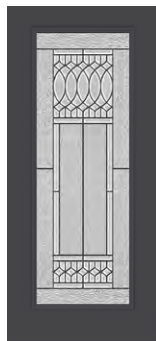

MARTIEL
page 122



MICRO-GRANITE
page 84

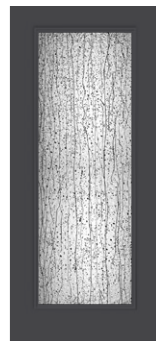

MISTIFY
page 110

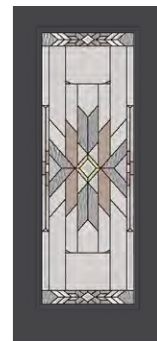

MOHAVE
page 124

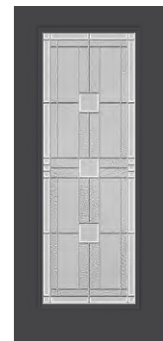

MONTEREY
page 100



VAPOR
page 92



VENTED GLASS
page 65

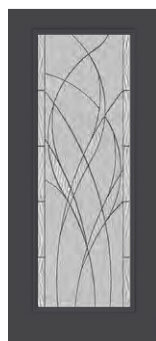

WATERSIDE
page 112

New Products



page
60

ADD CHARACTER TO YOUR ENTRY WITH WOODGRAIN DIVIDED LITES

Our ever-popular Modern Simulated Divided Lites collection is now available in woodgrain! Create a timeless look with Norwood Steel and Timberline Textured Fiberglass door styles, paired with your choice of Clear Low-E, privacy, or textured glass.



page
26

20-GAUGE STEEL DOORS WITH GLASS OPTIONS

Add security and style to your entryway with the WestGuard series. This durable, 20-gauge steel door is ideal for commercial jobs and high-traffic residential areas and is now available in your choice of clear, privacy, and decorative glass options.



page
28

MODERN SOLUTION FOR LARGE OPENINGS

The simplicity of the 2-Panel Flat Shaker makes it the perfect modern solution for large openings. This popular style is now available in 8/0 height for the Cambridge Smooth Steel and the WestGuard Steel series.



page
60

CREATE A STATEMENT WITH DIVIDED LITE STYLES

Offering simplicity and clean lines, our new 4-lite styles will add a touch of modernism to any entryway.

Modern Simulated Divided Lites are available with your choice of Clear Low-E, privacy, or textured glass.



page
66

CONTROL LIGHT & PRIVACY WITH ENCLOSED BLINDS

Enclosed Blinds doors are now available with matching sidelites in the White blind color. The light and privacy levels are yours to control using our easy operator.

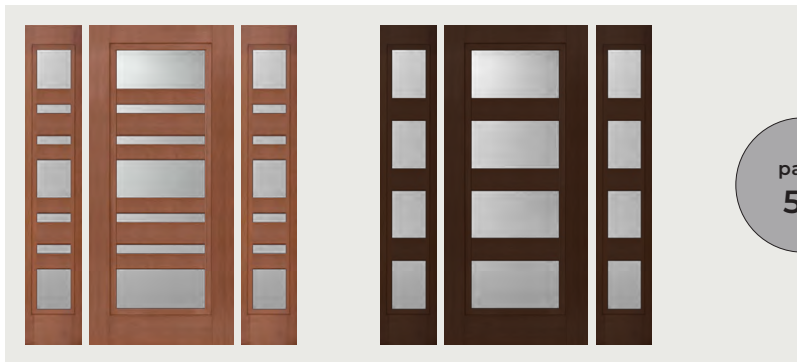

page
58

ADD DRAMATIC STYLE WITH MATCHING SIDELITES

Make a statement entryway with Contemporary Simulated Divided Lite doors and matching sidelites. The combination of wider bars and clear or privacy glass will create a truly extraordinary front door.

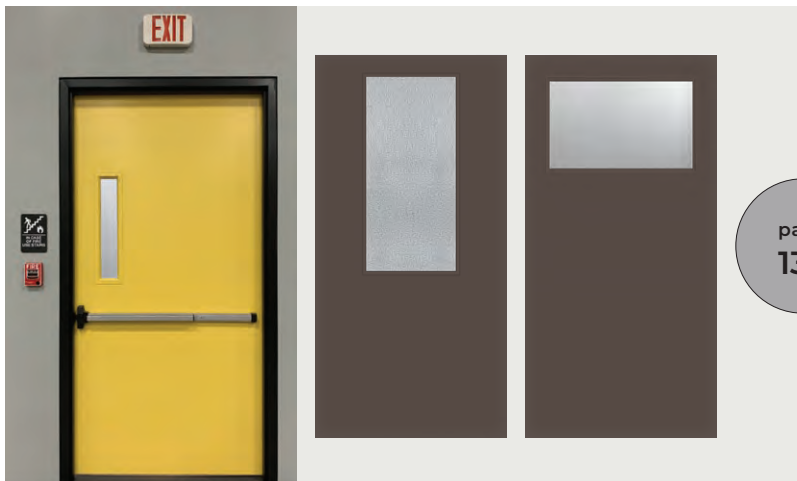

page
137

STRONGER, TALLER, AND WIDER DOORS

Add the security of 20-gauge steel and the convenience of a wide door with the WestGuard series. These styles are available in sizes up to 8 feet tall and 4 feet wide, with or without glass, and your choice of color.

DISCOVER *your style*

Updating the exterior of your home is an exciting time. The result should make you fall in love with your home every time you pull in the driveway. But what if you don't know what your design style is? Let us help you find your style and determine a direction for the look of your home.

Visit our website to uncover your design style and create a cohesive look that reflects you.



page
10

INDUSTRIAL

Industrial design often features a combination of wood and metal materials for the perfect mix of old and new. Exposed pipes and leather furniture in warm tones add to the overall aesthetic.



page
14

TRADITIONAL

Traditional design begins with the structure of the space. Sophisticated lines, ornate detailing, and deeply cut bevels provide an understated ambiance that is uniquely traditional.



page
11

CRAFTSMAN

Craftsman style houses are most well-known for their low-pitched overhanging roofs and column-heavy front porches. When it comes to craftsman design style, it is all about the details.



page
12

MODERN

Clean lines, uncluttered spaces and open layouts are elements of this style. It's not uncommon for pops of color to be incorporated through doors and accent pieces.



page
13

RUSTIC

Rustic design highlights the beauty of natural materials like stone accent walls and rough-hewn beams. Tarnished metals, burlap and repurposed objects are perfect details in a rustic home.



page
15

CONTEMPORARY

Truly an ever-evolving style as it reflects the trends of today. Color blocking, geometric wall art and high ceilings are commonplace in contemporary design.



page
16

COASTAL

At the beach, life is simple and that is reflected in coastal style. Furnishing and décor are uncomplicated and uncluttered allowing homeowners to enjoy the natural beauty and light of their home.



page
17

MID-CENTURY MODERN

This design has stood the test of time due to its focus on comfort and practicality paired with thoughtful design. Bold patterns and clean lines help to create a timeless appeal.

Industrial

HOME STYLE

While industrial style takes root from renovated warehouses, factories and other industrial spaces, the basic design concepts can be utilized in many homes with just about any structural style. Industrial design often features a combination of wood and metal materials for the perfect mix of old and new.



OXFORD
WHITE

LAKESHORE

HORIZON
GRAY

OFF THE
RECORD

FLANNEL
GRAY



Color palettes are generally kept neutral and are naturally inspired by preexisting elements of the space like slate, red brick, and concrete.



Exposed pipes, light fixtures featuring Edison bulbs and leather furniture in warm tones all add to the overall aesthetic.



Craftsman style houses are most well-known for their low-pitched overhanging roofs and column-heavy front porches. When it comes to craftsman design style, it is all about the details. Featuring statement fireplaces, built-in bookcases and thick trim and molding, this style truly stands the test of time.

Craftsman

HOME STYLE



It's not uncommon for each room to have its own color palette and hues tend to lean towards earthy and natural. Craftsman style design provides a warm, inviting and character-rich feel.



Modern HOME STYLE

Less is more when it comes to modern style. Clean lines, uncluttered spaces and open layouts are elements of this popular design style. It's all about emphasizing materials when it comes to modern design – think concrete, glass, wood and steel.



Neutral colors, whites, beiges and some shades of black, are popular choices for color palettes.

Though neutrals are preferred, it's not uncommon for pops of color to be incorporated through doors and accent pieces.

With modern home design you can achieve a bold look through simplicity and minimalism.

Rustic HOME STYLE

Rustic style highlights the beauty of natural materials like stone fireplaces and rough-hewn beams. Tarnished metals, burlap and repurposed objects are perfect details in a rustic home. You don't have to live in a log cabin to enjoy rustic design, you simply need to pull in natural elements with a focus on wood and stone.



Bring the beauty of the great outdoors into your entryway with our Rustic Glass Collection.

On left, Martiel glass.
On right, Mohave glass.



When creating a rustic look, it's common to mix and match the wood species of cabinets, doors, trim and floors, and bring in barn-inspired elements like sliding doors or wood beams.



Traditional

HOME STYLE

Traditional style is rooted in comfort and enduring beauty. Traditional design begins with the structure of the space. Sophisticated lines, ornate detailing, and deeply cut bevels provide an understated ambiance that is uniquely traditional. This design style brings a sense of distinction to a home.



Color palettes tend to lean towards soft neutrals and are most often paired with rich woods.



It's common to see patterned rugs, tufted upholsteries, and leather accents woven into the décor of traditional homes.



Contemporary design is truly an ever-evolving style as it reflects the trends of today. Color blocking, geometric wall art and high ceilings are commonplace in contemporary design. Similar to modern design, you'll find sleek, clean lines and notice decorative items are often omitted in favor of a more simplistic look.

Contemporary

HOME STYLE



Color palettes tend to lean more masculine and using shades of similar hues is common. Warmth and coziness are incorporated using textured rugs and patterned pillows.

Though ever-changing, contemporary design provides a sense of being rooted in simplicity.



Coastal

HOME STYLE

Inspired by rolling waves, sandy shorelines and cool breezes, it's no wonder coastal design is popular for beach-front properties and city dwellings alike.



A color palette of light, airy neutrals paired with ocean blues and greens help to keep a coastal vibe fluid from one room to the next.

At the beach, life is simple and that is reflected in coastal style. Furnishing and décor are uncomplicated and uncluttered, allowing homeowners to enjoy the natural beauty and light of their home.

Mid-Century Modern

HOME STYLE

The popularity of mid-century modern design has stood the test of time due to its focus on comfort and practicality paired with thoughtful design. Unlike many other styles, form follows function while highlighting the materials used, rather than making them something they aren't.



Traditional mid-century color palettes ranged from bright hues in the 1950s to earthy colors in the 1960s, so either option works today.

Today's design style often showcases color with statement pieces rather than entire rooms.



Bold patterns, Danish-style furniture and statement lighting all lend to the overall look.

Mid-century modern design fits with today's more casual lifestyle, open floor plans and focus on experience over things.



Curb Appeal

Not only will a new entry door increase your curb appeal, it can increase the value of your home too.

Entry door replacement consistently ranks among the most valuable remodeling projects in Remodeling magazine's Cost vs. Value Report. According to the Remodeling 2021 Cost vs. Value Report (www.costvsvalue.com), homeowners will recoup an average of 65% of their steel entry door costs.*

*©2021 Hanley Wood, LLC. Complete data from the Remodeling 2021 Cost vs. Value Report can be downloaded free at www.costvsvalue.com.

BEFORE



AFTER



Design Your Entry

**Designing your dream entryway has never been easier
with our easy-to-use home visualizer.**

Our interactive visualizer helps to bring your ideas to life in a few easy steps. Choose a sample home in the program or upload your own to start exploring different combinations of glass, color, door styles, hardware, and other details until you have one that's perfect for your home.

After your design is complete, you will receive a summary of the door you created. Print the details to share with your contractor, or share your personalized door design with family and friends on social media.

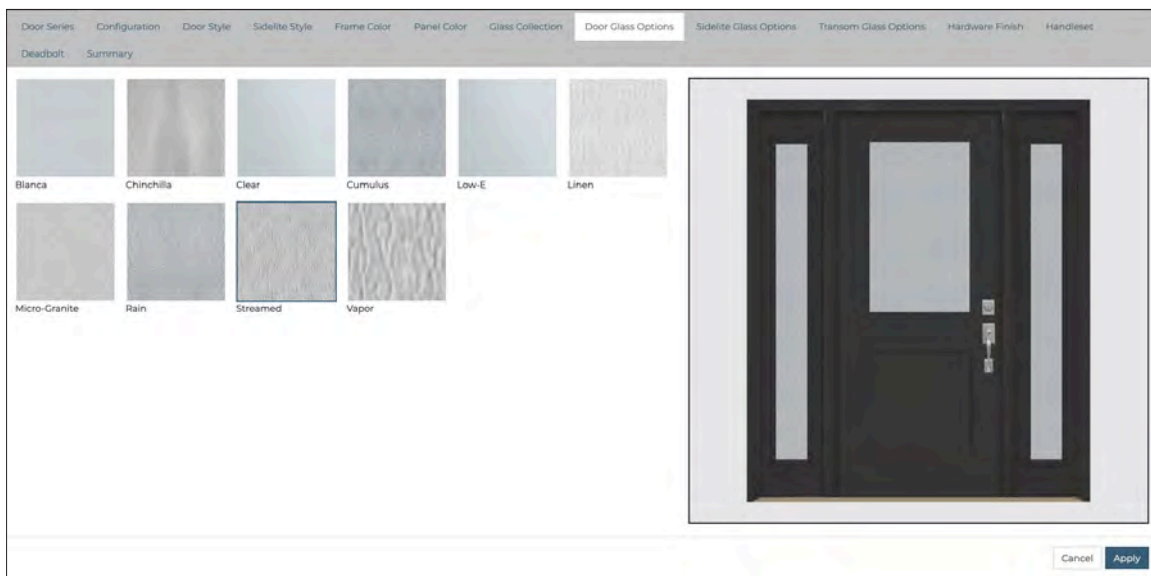



Built with Security

You can buy a new door just about anywhere.

A door is a door – from the street they tend to look the same for the most part...

SO, WHY BUY OUR DOOR?

A door is 1-3/4" thick.

1-3/4" between you...
and a severe storm
and a hot summer day
and subzero temperatures

1-3/4" thick between...
your possessions and a burglar
your home and a potential garage fire
your family and harm

A door is much more than looks.

IT'S SECURITY.





STEEL-EDGE



SPLIT WOOD EDGE

STEEL-EDGE ADVANTAGE **Grade 40 Security Rating**

Our steel-edge doors receive the highest rating possible in the industry's toughest forced entry test.

A door must withstand the force beyond 7 hits from a 100 pound test weight to achieve a Grade 40 rating.



TRILENNIUM® **MULTI-POINT LOCK**

Three full deadbolts mean:
3X the strength
3X the security
3X the performance

We're the only manufacturer with Multi-Point Locks on Grade 40 steel doors.

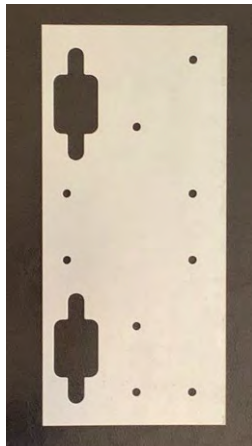

IMPROVED SECURITY

The steel jamb reinforcement plate attaches behind the jamb for additional security against forced entry. It's standard on all doors with a deadbolt.



FIRE RATED DOORS

All of our steel-edge doors have the ability to be labeled for 20 or 90 minute ratings.

Surrounded by Quality



DURA-FRAME™ JAMB

- Alaskan Yellow Cypress at the bottom of the jamb to resist rot and insects
- One-piece design, up to 12" depth, with no unsightly jamb extensions
- Limited lifetime warranty

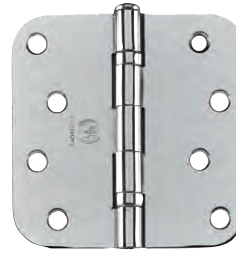

BALL-BEARING HINGES

- Reduces door squeak and eliminates grinding dust (black powder)
- Nine available finishes: Antique Brass, Antique Nickel, Bright Brass, Bright Chrome, Colonial Bronze, Dull Chrome, Matte Black, Satin Brass, and Satin Nickel

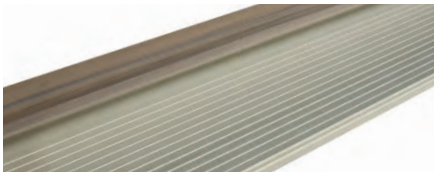

CONTINUOUS SILL

Creates a stronger system and reduces opportunity for air and water infiltration on sidelite units.

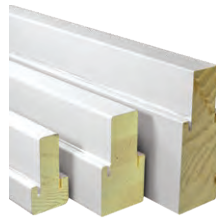

ONE PIECE MULLPOST

Adds strength and ensures your entrance system is storm door ready.



T-NUTS

T-nuts are used on all wood jambs to prevent hinge screws from stripping.





Built to Perform

IN ALL CLIMATES

The components of our exterior door system are engineered to work together, creating a weather-tight seal. Both steel and fiberglass doors are fully insulated with an inner core of polyurethane foam, which provides superior thermal performance and greater energy efficiency.

You'll save on energy costs for years to come. Many of our products have been certified in meeting ENERGY STAR qualifications.



ADJUSTABLE HINGE PLATE

- Allows the door to be adjusted up and down, in and out within the frame
- Adjustment allows for a tight fit against the weatherstrip and threshold
- Available in many door series and styles



AUTO-ADJUSTING SILL

- Z-Articulating Cap Sill® delivers constant protection against leaks, drafts and insects
- Stands up to wind and water
- No rotting, warping or deterioration over time
- Champagne sill standard, with optional Bronze or Mill finish

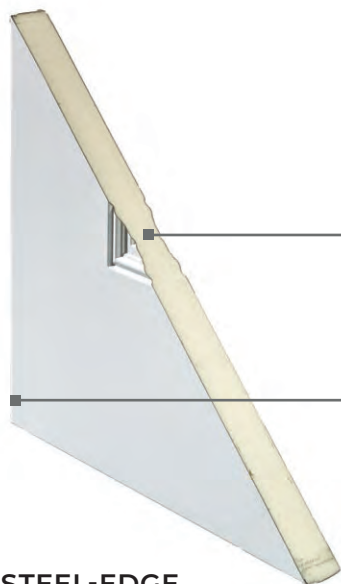

STEEL-EDGE DOORS

Timbergrain doors have 4" of engineered lumber on both the hinge and latch edges to keep the door straight and tight against the weatherstripping.

Polyurethane foam core fills every void to protect from heat loss or gain – five times more efficient than a wood door.

Steel-edge ensures a door will not rot, bow or warp, even under extreme conditions.







TIMBERGRAIN FIBERGLASS DOORS

Compare Door Series

DOOR SERIES	VALUELINE SMOOTH STEEL	CAMBRIDGE SMOOTH STEEL	WESTGUARD SMOOTH STEEL	NORWOOD TEXTURED STEEL
TEXTURE				
MATERIAL	24-gauge steel	22-gauge steel	20-gauge steel	22-gauge steel
WOOD GRAINS AVAILABLE	n/a	n/a	n/a	Oak
COLORS AVAILABLE	45 paint colors, custom paint colors	45 paint colors, custom paint colors	45 paint colors, custom paint colors	11 woodgrain finishes, 45 paint colors, custom paint colors
DOOR EDGE	full steel-edge perimeter	full steel-edge perimeter	full steel-edge perimeter	full steel-edge perimeter
INNER CORE	polyurethane foam core	polyurethane foam core	polyurethane foam core	polyurethane foam core
ADJUSTABILITY	auto-adjusting sill	adjustable hinge plate system, auto-adjusting sill	adjustable hinge plate system, auto-adjusting sill	adjustable hinge plate system, auto-adjusting sill
FIRE RATING	up to 90 minutes	up to 90 minutes	up to 90 minutes	up to 90 minutes
WARRANTY	10-year Limited	Limited Lifetime	Limited Lifetime	Limited Lifetime

Choose from our various steel, fiberglass, and wood door series to provide maximum protection and curb appeal for your home. A wide range of styles and textures are available to meet your architectural style or design needs.

DOOR SERIES	TRUGRAIN™ STEEL	TIMBERLINE SMOOTH & TEXTURED FIBERGLASS	TIMBERGRAIN FIBERGLASS	HERITAGE WOOD DOORS
TEXTURE				
MATERIAL	22-gauge steel with polyester coating	high-impact fiberglass reinforced skin	1/10" thick high-impact molded fiberglass skin	1-3/4" thick wood
WOOD GRAINS AVAILABLE	n/a	Fir	Cherry, Mahogany, Fir, Oak, Knotty Alder	Fir
COLORS AVAILABLE	Ludington, Holland, Rockport, Brimley	11 woodgrain finishes, 45 paint colors, custom paint colors	11 woodgrain finishes, 45 paint colors, custom paint colors	unfinished
DOOR EDGE	full steel-edge perimeter	full-length composite stiles & rails	4" full-length engineered hinge & lock stiles with rot-resistant edge, composite top & bottom rails	wood
INNER CORE	polyurethane foam core	polyurethane foam core	polyurethane foam core	wood
ADJUSTABILITY	adjustable hinge plate system, auto-adjusting sill	auto-adjusting sill	adjustable hinge plate system, auto-adjusting sill	adjustable hinge plate system, auto-adjusting sill
FIRE RATING	up to 90 minutes	n/a	n/a	n/a
WARRANTY	10-year Limited	25-year Limited (smooth); Limited Lifetime (textured)	Limited Lifetime	1-year Limited



WESTGUARD

SMOOTH STEEL DOOR SERIES

Tougher than ever and built for superior performance. The WestGuard Door Series is constructed out of durable, 20-gauge, hot-dipped galvanized steel and is ideal for commercial applications and high-traffic residential areas.

- 20-gauge steel
- Full steel-edge perimeter offers additional strength and the industry's highest security rating
- Resists cracking, splitting, warping, twisting, rotting, and corrosion
- Adjustable Hinge Plate System
- 20-gauge hinge reinforcements
- Polyurethane foam inner core provides superior insulation
- Composite lock block provides secure mounting for door hardware.
- Most styles available with 10" bottom rails to meet ADA requirements.
- G40 Hot-Dipped Galvanized Steel – more resistant to rust than typical, electro-galvanized doors, even in high moisture or coastal environments.
- Fire rated up to 90 minutes
- Limited lifetime warranty

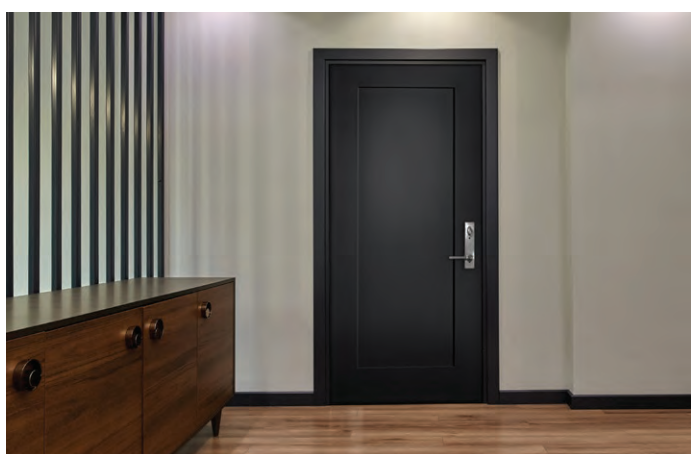

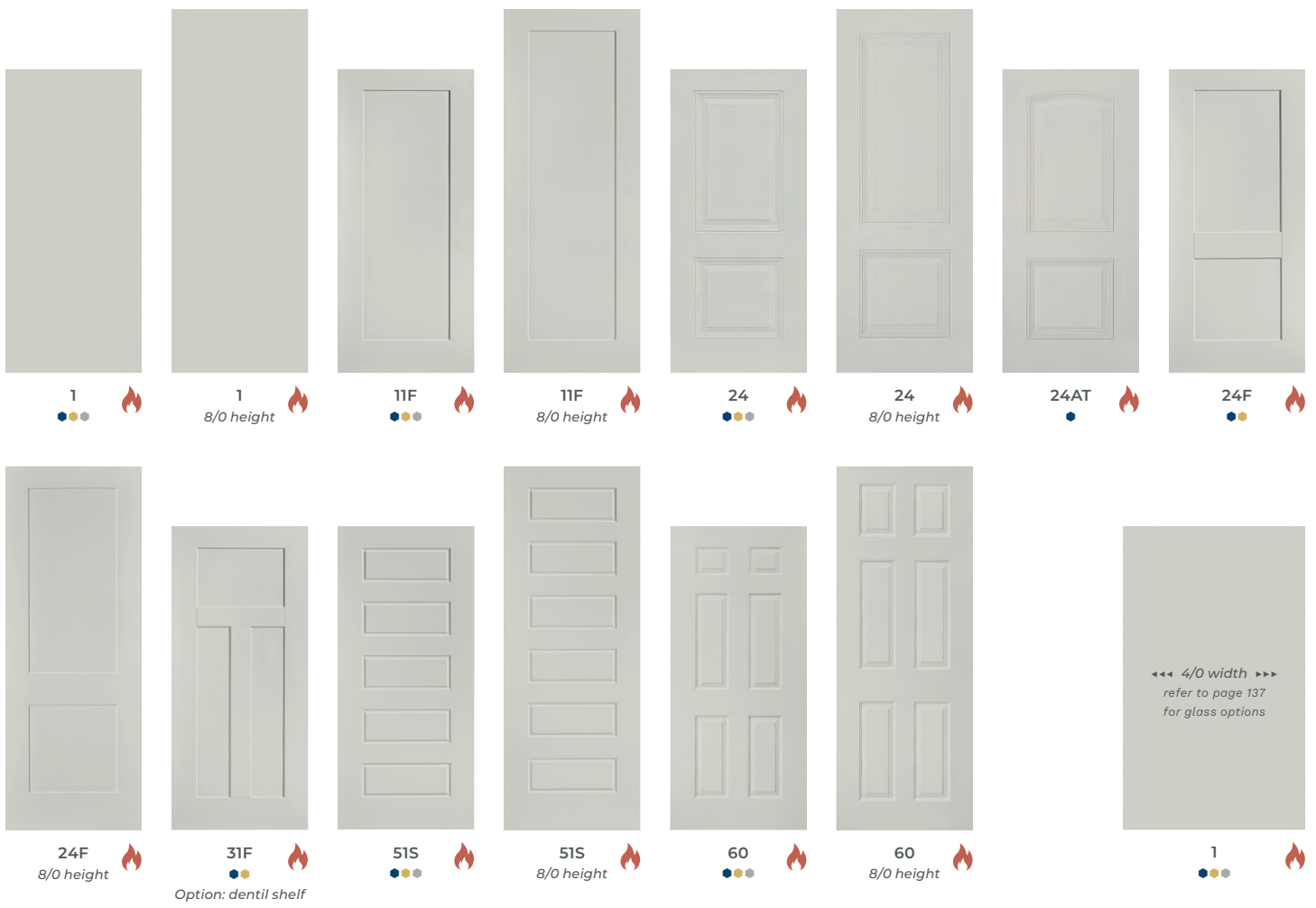

Availability based on 3/0 width. ● 6/8 height ● 7/0 height ● 8/0 height Other panel configurations and sizes may be available. 🔥 Can be labeled for fire rating.

CUSTOM CAPABILITIES

Customize your door with a special lock, face bore, or edge prep that a commercial job may require.

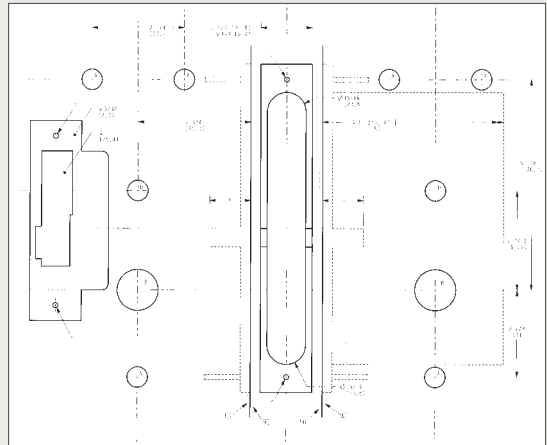

CLOSER AND PANIC BAR PREPS

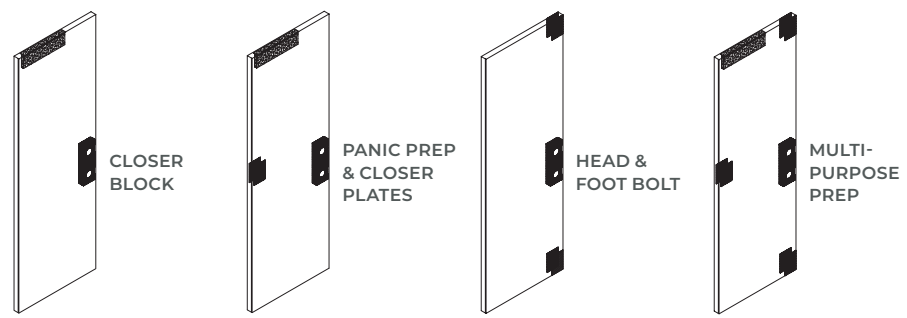



CAMBRIDGE

SMOOTH STEEL DOOR SERIES



Cambridge smooth steel doors are designed for strength, security and durability. This premium, insulated door system is constructed with a full steel-edge perimeter that offers additional strength and the industry's highest security rating.

- 22-gauge steel for increased durability; 40% thicker than bargain doors
- Full steel-edge perimeter offers additional strength and the industry's highest security rating
- Resists denting, cracking, splitting, warping and twisting
- Adjustable Hinge Plate System
- Polyurethane foam core fills every void to protect from heat loss or gain
- Composite lock block provides secure mounting for door hardware. Won't absorb moisture or swell like wood lock blocks.
- G40 Hot-Dipped Galvanized Steel – more resistant to rust than typical, electro-galvanized doors, even in high moisture or coastal environments.
- Fire rated up to 90 minutes
- Limited lifetime warranty





Availability based on 3/0 width.

-  6/8 height
-  7/0 height
-  8/0 height

Other panel configurations and sizes may be available.

 Can be labeled for fire rating.



DENTIL SHELF





VALUELINE

SMOOTH STEEL DOORS

Enhance your curb appeal and add value to your home with Valueline doors, available in a range of panel designs ideal for both home and garage entryways. The fully insulated core provides superior thermal performance and energy efficiency.

- Energy savings and curb appeal at a value
- Full steel-edge perimeter offers additional strength and the industry's highest security rating
- 24-gauge steel
- Polyurethane foam core fills every void to protect from heat loss or gain
- Fire rated up to 90 minutes
- 10-year limited warranty



D-1



D-24



D-31



D-60



D-90



Option: dentil shelf

Availability based on 3/0 width.

● 6/8 height

Other panel configurations and sizes may be available.



Can be labeled for fire rating.



NORWOOD

TEXTURED STEEL DOOR SERIES

The warmth of wood meets the strength of steel with the Norwood series. These textured steel doors are constructed with a deeply embossed Oak grain surface.

- Deep grain embossment gives a realistic wood appearance
- 22-gauge steel
- Adjustable Hinge Plate System
- Fire rated up to 90 minutes
- Full steel-edge perimeter offers additional strength and the industry's highest security rating
- Limited lifetime warranty



DENTIL SHELF



11F

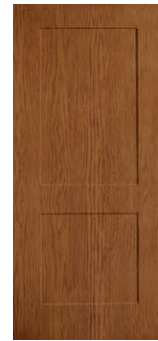

24F



31F
Option: dentil shelf



1

1 8/0 height

24

24 8/0 height

24PAT

60

60 8/0 height

80



TRUGRAIN™

WOODGRAIN STEEL DOOR SERIES

Trugrain™ doors combine the natural, timeless look of wood with the strength of steel. These doors are constructed of 22-gauge steel with a scratch-resistant coating that replicates a realistic wood appearance.

Availability based on 3/0 width.

- 6/8 height
- 7/0 height
- 8/0 height

Other panel configurations and sizes may be available.

 Can be labeled for fire rating.

- 22-gauge steel for increased durability
- Vertically grain pattern in four color options: Ludington, Rockport, Holland, and Brimley
- No finishing or maintenance required
- Full steel-edge perimeter offers additional strength and the industry's highest security rating
- Resists denting, cracking, splitting, warping and twisting
- Adjustable Hinge Plate System
- Polyurethane foam core fills every void to protect from heat loss or gain
- Fire rated up to 90 minutes
- 10-year limited warranty







TIMBERLINE

FIBERGLASS DOOR SERIES

The Timberline fiberglass door series is designed with energy and thermal performance in mind, while providing depth and dimension to your entryway.

- Smooth and Fir woodgrain
- Unaffected by moisture and humidity
- Withstands everyday use and all surfaces are easy to clean
- Made from high-impact fiberglass reinforced skins
- Full-length composite stiles and rails with HydroShield provide a 6-sided protection against water infiltration, mold, and insects
- Polyurethane foam core fills every void to protect from heat loss or gain
- 25-year limited warranty (Smooth); limited lifetime warranty (Fir)





Availability based on 3/0 width. ● 6/8 height ● 7/0 height ● 8/0 height Other panel configurations and sizes may be available.





TIMBERGRAIN

FIBERGLASS DOOR SERIES

Timbergrain fiberglass entrance doors offer the warmth of wood and its natural characteristics in five different species: Knotty Alder, Mahogany, Cherry, Fir, and Oak.

- Stronger dimensions and crisper shadow lines to replicate the look and texture of real wood doors
- 1/10" thick fiberglass skin, 40% thicker than bargain doors
- Adjustable Hinge Plate System
- Premium hardwood edges replicate the look of a real wood door while resisting rot and decay.
- 4" Laminated Strand Lumber (LSL) stiles provide strength and protects against thermal bowing and warping.
- Composite top & bottom rails won't absorb moisture and will not rot or decay like wood.
- Limited lifetime warranty





Classic
CHERRY



30
Cherry, Mahogany,
Oak ●●●



34
Cherry ●●●
Oak ●●●

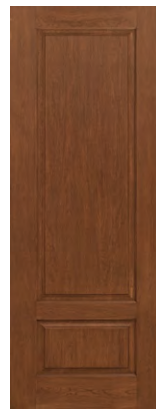

34
8/0 height



60
Cherry, Mahogany,
Oak ●●●



Classic
OAK

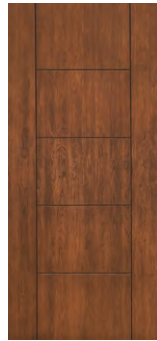

C500
Cherry ●

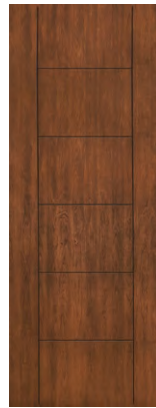

C550
Cherry ●

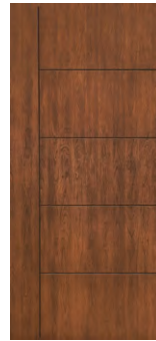

C501
Cherry ●

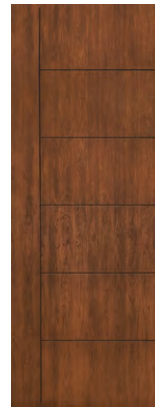

C551
Cherry ●



Craftsman
FIR



11F
Fir ●●●



31
Fir ●●●
Option: dentil shelf



Classic
MAHOGANY



Rustic
CHERRY



34AT-R
Cherry ●●●

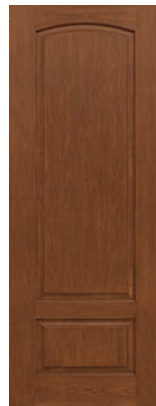

34AT-R
8/0 height



34PAT-R
Cherry ●●●

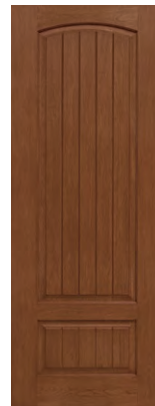

34PAT-R
8/0 height



11F
8/0 height



31
8/0 height



Rustic
KNOTTY ALDER

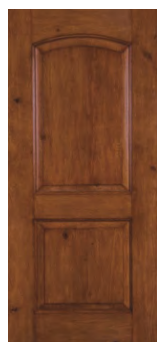

24AT
Knotty Alder ●●●



24AT
8/0 height



24PAT
Knotty Alder ●●●



24PAT
8/0 height

Availability based on 3/0 width.
● 6/8 height
● 7/0 height
● 8/0 height
Other panel configurations and sizes may be available.



HERITAGE

WOOD DOOR SERIES

Heritage wood door entrances set the tone for your home and make lasting impressions. Built to last a lifetime, our finely crafted entry doors will stand up to the seasons and stand proudly to welcome future generations.

- Handcrafted designs provide increased value and curb appeal to your home.
- 1-3/4" thickness
- Fir species
- Adjustable Hinge Plate System
- True Divided Lite (TDL) and Clear glass options
- Available sizes: 3/0 x 6/8 for doors and 14" for sidelites
- 1-year limited warranty

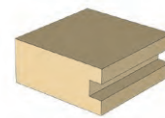

SQUARE STICKING

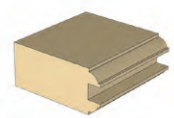

OVOLO STICKING





4077G
square sticking



4482
ovolo sticking
1-3/8" TDL



4515
ovolo sticking
1-3/8" TDL



4624
ovolo sticking
1-3/8" TDL



4626
ovolo sticking
1-3/8" TDL



4632
square sticking
2" TDL
Option: dentil shelf



4662
square sticking
2" TDL
Option: dentil shelf



4077
square sticking



4082
ovolo sticking

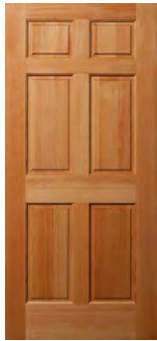

4130
ovolo sticking

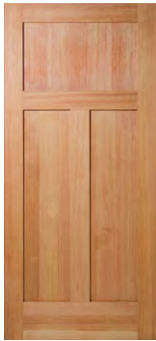

9033
square sticking
Option: dentil shelf



DENTIL SHELF
small block



DENTIL SHELF
large block

Dentil shelves represent a timeless traditional treatment that adds style and dimension to any door. [Available where noted]



4077G SL
square sticking



4624 SL
ovolo sticking
1-3/8" TDL



4626 SL
ovolo sticking
1-3/8" TDL



4661 SL
square sticking



4662 SL
square sticking
2" TDL



4701 SL
ovolo sticking



4705 SL
ovolo sticking
1-3/8" TDL



NOTE: Heritage series is available with glass options as shown above. Other glass styles noted within catalog are unavailable in this series.

Choose Your Glass Style

Embrace the natural light and transform your entryway with handcrafted doorglass. Our timeless designs create curb appeal, offer privacy, and personalize your home. Each piece of handcrafted glass is unique, just like you.



Featured with MONTEREY glass
see page 100 for application image

ZEEL GLASS FRAMES

These clean, low-profile glass frames blend seamlessly into the entry door, allowing the doorglass to take center stage.

- Matches your door panel color
- Innovative clip system eliminates screws and caps
- Resists scalloping and warping in severe temperatures and direct sunlight, even when painted dark colors
- Resolve® sealant is immune to squeeze out and doesn't degrade over time

NOTE: Standard on many styles in the Cambridge, Norwood, Trugrain™ and Valueline Steel, and Timberline Fiberglass door series. Ask your representative for details.



CLEAR GLASS

page 42

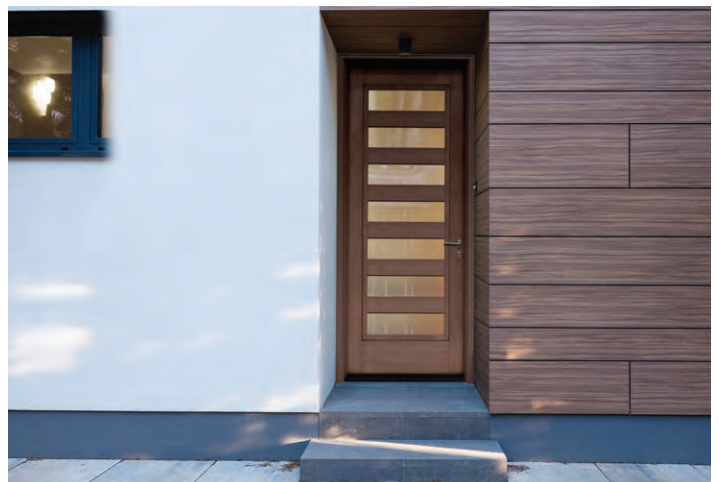

GRILLES & DIVIDED LITES

page 48



VENTED LITES

page 65



ENCLOSED BLINDS

page 66

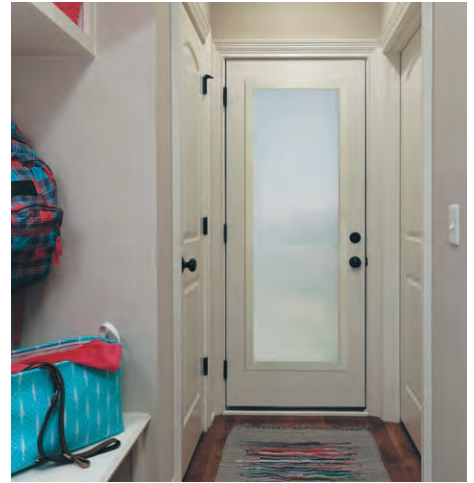

PRIVACY

page 68



CRAFTSMAN

page 94



URBAN

page 104



MODERN

page 114



RUSTIC

page 120



TRADITIONAL

page 126



CLEAR GLASS

If you want the view and nothing but the view, Clear Glass is your answer. It is an option that works equally well from your entry door to your patio door. Most styles available with Low-E or Rain glass options.

Privacy Rating: 0 TRANSPARENT OPAQUE

	CAMBRIDGE SMOOTH	WESTGUARD SMOOTH	NORWOOD TEXTURED	TRUGRAIN™	VALUELINE	TIMBERLINE SMOOTH	TIMBERLINE TEXTURED FIR	TIMBERGRAIN CHERRY	TIMBERGRAIN FIR	TIMBERGRAIN KNOTTY ALDER	TIMBERGRAIN MAHOGANY	TIMBERGRAIN OAK
	STEEL DOORS						FIBERGLASS DOORS					
2	●●●	●●			●	●●●						
3-15	●●●	●●			●	●						
3C-15	●●●	●●			●	●●						
20	●●		●●●			●		●●			●●	●●
21	●●●	●●	●●●	●●●	●	●●●	●	●●	●●●	●●	●●	●●
23	●●●	●●	●●●			●●						
25	●●●	●●	●●●		●	●●				●●●		
25P	●		●							●●●		
41					●							
61	●●●	●●	●●●	●●●	●	●●		●●			●●	●●
65	●●	●	●●	●●	●	●						
68	●●	●	●●	●●	●	●						
70	●●		●●		●	●						
201	●●					●●		●●●				●●
201P								●●●				
461C	●●	●	●●			●						
502S	●●	●										
601								●●				
601P								●●				
608								●●			●●	●●
648								●●			●●	●●

Availability based on 3/0 width for doors and 14" for sidelites. ● 6/8 height ● 7/0 height ● 8/0 height
Other panel configurations and sizes may be available.

Additional panels and sidelites on the following pages.

Clear glass complements any home style





CLEAR GLASS

If you want the view and nothing but the view, Clear Glass is your answer. It is an option that works equally well from your entry door to your patio door. Most styles available with Low-E or Rain glass options.

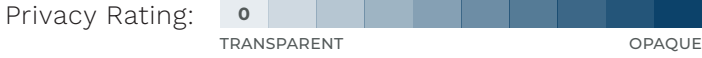

	CAMBRIDGE SMOOTH	WESTGUARD SMOOTH	NORWOOD TEXTURED	TRUGRAIN™	VALUELINE	TIMBERLINE SMOOTH	TIMBERLINE TEXTURED FIR	TIMBERGRAIN CHERRY	TIMBERGRAIN FIR	TIMBERGRAIN KNOTTY ALDER	TIMBERGRAIN MAHOGANY	TIMBERGRAIN OAK
	STEEL DOORS						FIBERGLASS DOORS					
651	●●●	●●	●●●	●●●		●●●						
651A	●●●	●●	●●●	●●●		●●●						
651B-1	●●	●										
651B-2	●●	●										
651B-12	●●	●										
651B-23	●●	●										
651B-24	●●	●										
651B-123	●●	●										
651B-135	●●	●										
651B-1234	●●	●										
651B-55	●●	●				●●						
694-1	●●●	●●	●●	●●		●●						
840	●●●	●●	●●●	●●●		●●●						
840A	●●●	●●	●●●	●●●		●●●						
842	●●●	●●	●●●	●●●		●●●						
842A	●●●	●●	●●●	●●●		●●●						
843	●●●	●●	●●●	●●●		●●●						
843A	●●●	●●	●●●	●●●		●●●						
843B	●●●	●●	●●●	●●●		●●●						
864								●●●				
865						●●	●●					
866	●●				●							
866-FL	●	●	●			●●						
866F	●●	●	●	●●								
866P	●											
937								●●				
937A								●●				
937C								●●			●●	●●
973										●		
973P										●		
984F	●●●	●●	●	●●		●	●					

Availability based on 3/0 width for doors and 14" for sidelites. ● 6/8 height ● 7/0 height ● 8/0 height
Other panel configurations and sizes may be available.

Additional panels and sidelites on the previous page.

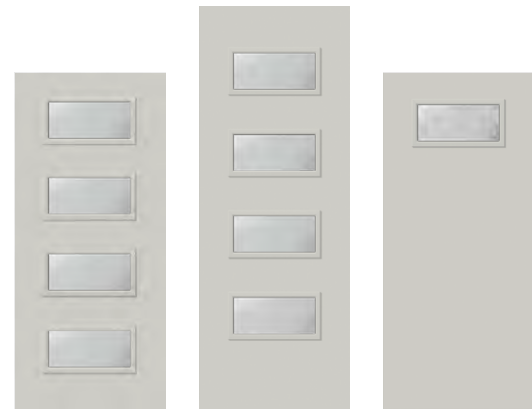

651

651
8/0 height

651A



651B-1234

651B-55

694-1
left or right

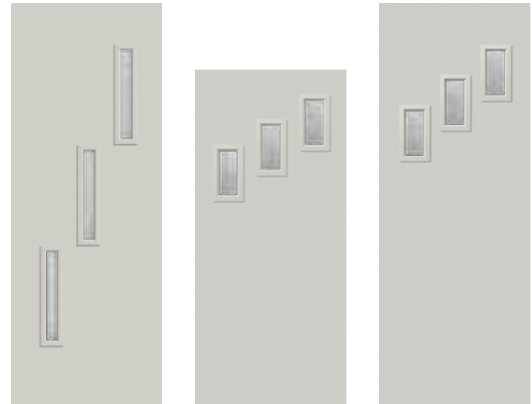

842A left or right
8/0 height

843 left or right

843 left or right
8/0 height



866

866-FL

866F

Option: dentil shelf

Option: dentil shelf

Option: dentil shelf
(Cambridge & Norwood)

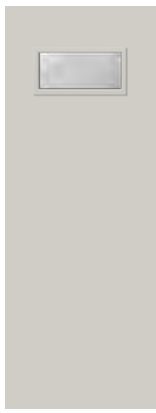

651A
8/0 height



651B-1



651B-2



651B-12



651B-23



651B-24



651B-123



651B-135



694-1
8/0 height
left or right



840

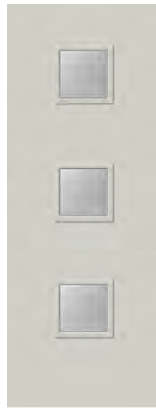

840
8/0 height



840A



840A
8/0 height



842



842
8/0 height

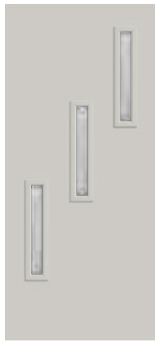

842A left or right

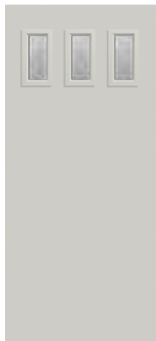

843A

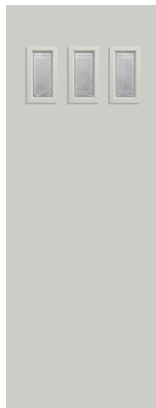

843A
8/0 height



843B left or right



843B left or right
8/0 height



864
Option: dentil shelf



864
8/0 height
Option: dentil shelf



865
Option: dentil shelf



865
8/0 height
Option: dentil shelf



866P
Option: dentil shelf



937



937A



937C



973
8/0 height



973P
8/0 height



984F



984F
8/0 height 45



CLEAR GLASS *sidelites*

	CAMBRIDGE SMOOTH	WESTGUARD SMOOTH	NORWOOD TEXTURED	TRUGRAIN™	VALUELINE	TIMBERLINE SMOOTH	TIMBERLINE TEXTURED FIR	TIMBERGRAIN CHERRY	TIMBERGRAIN FIR	TIMBERGRAIN KNOTTY ALDER	TIMBERGRAIN MAHOGANY	TIMBERGRAIN OAK
	STEEL SIDELITES						FIBERGLASS SIDELITES					
4	●●●		●●●	●●●		●●●						
5 (direct set)	●●●	●●●	●●●	●●●	●●●	●●●	●●●	●●●	●●●	●●●	●●●	●●●
33	●●		●	●●		●		●●●		●●●	●●	●●
38	●		●			●		●●●			●●	●●
105	●●		●●	●●		●						
690								●●	●●	●●	●●	●●
820								●●				

Availability based on 3/0 width for doors and 14" for sidelites. ● 6/8 height ● 7/0 height ● 8/0 height
Other panel configurations and sizes may be available.

*sidelites add more light
in your home*



4 4 5 5 33 33
8/0 8/0 8/0 8/0



38 38 105 690 820
8/0 8/0



CLEAR GLASS

Transoms

Transoms allow extra light into the entryway and are available in several shapes: rectangle, half circle, and elliptical. The transoms are a direct-set profile with Low-E glass as standard.

*Bring in more natural light
without sacrificing privacy*



TR91
11-1/2" height



TR99
11-1/2" height



TR96
ELLIPTICAL
11-1/2" height



TR89
15-1/2" height



TR90
15-1/2" height



TR94
ELLIPTICAL
15-1/2" height



TR92
20-5/8" height



TR98
20-5/8" height



TR97
ELLIPTICAL
20-5/8" height



TR95
HALF CIRCLE
call for height



TR93
HALF CIRCLE
call for height



design tip

Pair a transom with a solid panel door to add more light in your foyer



GRILLES

Collection

Add a bold look to your home with grille patterns in your entry or patio doors, sidelites and transoms. Choose from numerous patterns to fit your home's architectural style.



INTERNAL GRILLES
COLONIAL



INTERNAL GRILLES
PRAIRIE



INTERNAL GRILLES
ARTS & CRAFTS



SIMULATED
DIVIDED LITES

design ————
 └───┬───┐
 YOUR HOME

+ configurations are designed to coordinate with popular window patterns

+ choose Simulated Divided Lites to create the look of authentic divided lites, but with greater energy efficiency

INTERNAL GRILLES

Internal grilles feature bars between two panes of insulating glass. This style simplifies maintenance for homeowners, allowing the inner and outer glass surfaces to be easily cleaned.

Privacy Rating: 1 TRANSPARENT OPAQUE

INTERNAL GRILLES	INTERNAL GRILLES																							
	PRAIRIE	CAMBRIDGE SMOOTH	WESTGUARD SMOOTH	NORWOOD TEXTURED	TRUGRAIN™	VALUELINE	TIMBERLINE SMOOTH	TIMBERLINE TEXTURED FIR	TIMBERGRAIN CHERRY	TIMBERGRAIN FIR	TIMBERGRAIN KNOTTY ALDER	TIMBERGRAIN MAHOGANY	TIMBERGRAIN OAK											
STEEL DOORS						FIBERGLASS DOORS						STEEL SIDELITES						FIBERGLASS SIDELITES						
2-9LP	●●	●				●	●●																	
20-9LP	●●			●●●			●		●●				●●										●●	●●
22-9LP	●●		●	●●	●●	●	●●																	
23-6LP	●●		●	●●			●																	
25-9LP	●●		●	●	●●●	●	●●						●●●											
25P-9LP	●			●									●●●											
43-9LP						●																		
63-6LP	●●●	●●	●●	●●●	●●●	●	●●		●●				●●							●●		●●		●●
69-9LP	●●		●	●●		●	●																	
201-9LP	●●						●●						●●											●●
201P-9LP													●●											
502S-9LP	●●		●																					
864-9LP													●●●											
865-9LP							●		●															
866-9LP	●●					●																		
866F-9LP	●●		●	●	●●																			
866P-9LP	●																							
984F-9LP	●●		●	●	●●		●		●															
3-6LP	●●			●●	●		●●																	
5-6LP (direct set)	●●	●●	●●	●●	●●	●●	●●	●●	●●	●●	●●	●●	●●	●●	●●	●●	●●	●●	●●	●●	●●	●●	●●	●●
34-6LP	●			●			●						●●							●●		●●		●●
38-6LP	●												●●●							●●		●●		●●
690-6LP													●●	●●	●●	●●	●●	●●	●●	●●	●●	●●	●●	●●

Availability based on 3/0 width for doors and 14" for sidelites. ● 6/8 height ● 7/0 height ● 8/0 height
Other panel configurations and sizes may be available.

INTERNAL GRILLE COLORS

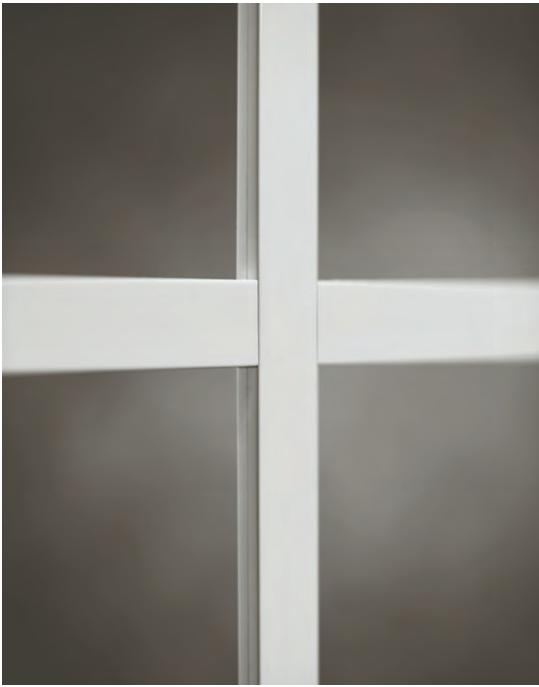

a natural approach to design





Prairie
**INTERNAL
 GRILLES**

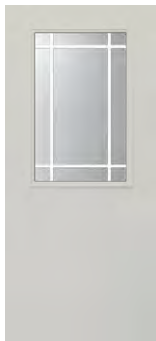

2-9LP



25-9LP



25P-9LP



43-9LP



63-9LP



502S-9LP



984F-9LP



20-9LP



201-9LP



201P-9LP



22-9LP



23-6LP



69-6LP



864-9LP

Option: dentil shelf



865-9LP

Option: dentil shelf



866-9LP

Option: dentil shelf



866F-9LP

*Option: dentil shelf
 (Cambridge & Norwood)*



866P-9LP

Option: dentil shelf



3-6LP



34-6LP



38-6LP



5-6LP

Direct Set



690-6LP

Colonial INTERNAL GRILLES



864-3L
3L or 6L
Option: dentil shelf



865-3L
3L or 6L
Option: dentil shelf



866-3L
3L or 6L
Option: dentil shelf



866F-6L
3L or 6L
*Option: dentil shelf
(Cambridge & Norwood)*



866P-6L
3L or 6L
Option: dentil shelf



22-4L



22-4LH



22-6L



22-8L



22-10L



22-15L



23-4L



23-5L

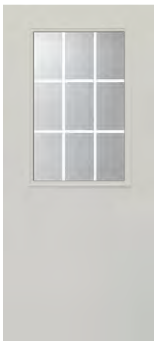

2-9L



25-4L
4L or 9L



25P-4L
4L or 9L

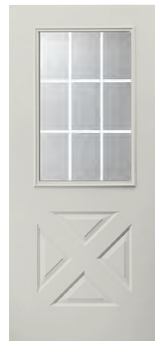

43-9L



63-4L
4L or 9L



502S-9L
4L or 9L



984F-4L
4L or 9L



69-2L



69-3L



20-3L,
4L, 6L, 8L or 12L



201-4L,
3L, 6L, 8L or 12L



201P-6L,
3L, 4L, 8L or 12L



201-8L,
3L, 4L, 6L or 12L



201-12L,
3L, 4L, 6L, or 8L



70-5L



648-6L



23-2L



23-3L



3-2L



3-3L



3-4L



3-5L



690-5L



34-2L



34-3L



38-4L



5-6L
Direct Set

INTERNAL GRILLES	COLONIAL	GRID PATTERN	CAMBRIDGE SMOOTH	WESTGUARD SMOOTH	NORWOOD TEXTURED	TRUGRAIN™	VALUELINE	TIMBERLINE SMOOTH	TIMBERLINE TEXTURED FIR	TIMBERGRAIN CHERRY	TIMBERGRAIN FIR	TIMBERGRAIN KNOTTY ALDER	TIMBERGRAIN MAHOGANY	TIMBERGRAIN OAK
2		9L	●●	●			●	●●						
20		3L	●●		●●			●		●●			●●	●●
20		4L, 6L, 8L	●●		●●●			●		●●			●●	●●
20		4LH, 10L			●									
20		12L (8/0 is 15L)	●●		●●●			●		●●			●●	●●
22		4L, 4LH, 6L, 8L	●●●	●●	●●●	●●●		●●●						
22		10L (8/0 is 12L)	●●●	●●	●●●		●	●●●						
22		15L (8/0 is 18L)	●●●	●●	●●●	●●●	●	●●●	●	●●	●●	●●	●●	●●
23		2L, 3L, 4L	●●●	●●	●●●			●●●						
23		5L (8/0 is 6L)	●●●	●●	●●●			●●●						
25		4L	●●●	●●	●●●			●●				●●●		
25		3L, 6L, 8L	●	●	●			●				●		
25		9L (8/0 is 12L)	●●●		●●●		●	●●				●●●		
25P		4L	●		●							●●		
25P		9L (8/0 is 12L)	●		●							●●●		
43		9L					●							
63		4L	●●●	●●	●●●	●●●		●●		●●			●●	●●
63		3L, 6L, 8L	●	●	●	●		●						
63		9L (8/0 is 12L)	●●●	●●	●●●	●●●	●	●●		●●			●●	●●
69		2L	●●	●	●●			●						
69		3L	●●	●	●●		●	●						
70		5L	●●		●●		●	●						
201		3L	●●					●		●●				●●
201		4L	●●					●●		●●				●●
201		4LH, 10L						●						
201		6L, 8L	●●					●●		●●				●●
201		12L (8/0 is 15L)	●●					●●		●●●				●●
201P		3L								●●				
201P		4LH								●				
201P		4L, 6L, 8L								●●●				
201P		12L (8/0 is 15L)								●●●				
502S		4L, 9L	●●	●										
648		6L								●●			●●	●●
864		3L, 6L									●●●			
865		3L, 6L						●	●					
866		3L, 6L	●●				●							
866F		3L, 6L	●●	●	●	●●								
866FL		6L		●										
866P		3L, 6L	●											
984F		4L	●●●	●●	●	●●		●						
984F		9L	●●	●	●	●●		●						
984F		3L, 6L, 8L, 12L	●	●										
STEEL SIDELITES							FIBERGLASS SIDELITES							
3		2L, 3L, 4L	●●●		●●●	●		●●●						
3		5L (8/0 is 6L)	●●●		●●●	●		●●●						
34		2L, 3L	●		●●	●		●		●●			●●	●●
38		2L, 3L, 5L	●					●						
38		4L	●					●		●●●			●●	●●
5 (direct set)		6L (8/0 is 7L)	●●	●●	●●	●●	●●	●●	●●	●●	●●	●●	●●	●●
690		5L								●●	●●	●●	●●	●●

Availability based on 3/0 width for doors and 14" for sidelites. ● 6/8 height ● 7/0 height ● 8/0 height
Other panel configurations and sizes may be available.

Arts & Crafts

INTERNAL GRILLES

Arts & Crafts grilles offer homeowners the simple lines that match Arts & Crafts and Craftsman style homes most often associated with Gustav Stickley and Franklin Lloyd Wright.



a touch of style without compromising the view



INTERNAL GRILLES ARTS & CRAFTS	GRID PATTERN	STEEL DOORS				FIBERGLASS DOORS				
		CAMBRIDGE SMOOTH	WESTGUARD SMOOTH	NORWOOD TEXTURED	TRUGRAIN™	TIMBERLINE SMOOTH	TIMBERLINE TEXTURED FIR	TIMBERGRAIN CHERRY	TIMBERGRAIN MAHOGANY	TIMBERGRAIN OAK
201 / 606	3L, 4L	●●				●				
502S	3L, 4L	●●	●							
607	3L, 4L	●●		●●		●		●●	●●	●●
684	3L, 4L	●●	●	●●		●		●●	●●	●●
686	3L, 4L	●●●	●●	●●●		●●●				
984	3L, 4L	●●	●	●●		●●				
984F	3L, 4L	●●	●	●	●●	●		●		
		STEEL SIDELITES				FIBERGLASS SIDELITES				
422	3L					●				
694	3L	●●		●●		●●●				

Availability based on 3/0 width for doors and 14" for sidelites. ● 6/8 height ● 7/0 height ● 8/0 height
Other panel configurations and sizes may be available.



502S-3LAC
3L or 4L

684-3LAC
3L or 4L

25-4LAC
3L or 4L

984F-4LAC
3L or 4L



201-3LAC
3L or 4L

607-4LAC
3L or 4L

686-4LAC
3L or 4L

694-3LAC

INTERNAL GRILLES

transoms

Transoms allow extra light into the entryway and are available in several shapes: rectangle, half circle, and elliptical. The transoms are a direct-set profile with Low-E glass as standard.



TR91 - 3L
11-1/2" height



TR91 - 6LP
11-1/2" height



TR91 - SUNBURST
11-1/2" height



TR99 - 5L
11-1/2" height



TR99 - SUNBURST
11-1/2" height



TR89 - 3L
15-1/2" height



TR89 - 6LP
15-1/2" height



TR89 - SUNBURST
15-1/2" height



TR90 - 5L
15-1/2" height



TR90 - 6LP
15-1/2" height



TR90 - SUNBURST
15-1/2" height



TR92 - 3L
20-5/8" height



TR92 - 9LP
20-5/8" height



TR92 - SUNBURST
20-5/8" height



TR98 - 5L
20-5/8" height



TR98 - 9LP
20-5/8" height



TR98 - SUNBURST
20-5/8" height



TR96 - SUNBURST
ELLIPTICAL
11-1/2" height



TR94 - SUNBURST
ELLIPTICAL
15-1/2" height



TR97 - SUNBURST
ELLIPTICAL
20-5/8" height



TR95 - SUNBURST
HALF CIRCLE
call for height



TR93 - SUNBURST
HALF CIRCLE
call for height



Timbergrain SIMULATED DIVIDED LITES

The Timbergrain simulated divided lites (SDL) collection feature woodgrain bars to add depth and dimension to your front door. SDL doors capture the elegance of traditional divided lites, with added energy performance.



SDL profile for Fir grain



SDL profile for Cherry, Oak, Mahogany and Knotty Alder grain

Glass Code: SDL

Privacy Rating:
TRANSPARENT 6 8 9 OPAQUE

GLASS OPTIONS

SDL doors are available with Clear Low-E or your choice of privacy and textured glass.

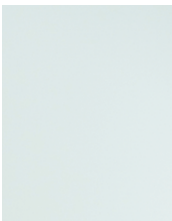

BLANCA
Privacy: 9

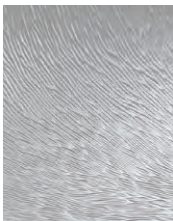

CHINCHILLA
Privacy: 9



CLEAR LOW-E
Privacy: 1



CUMULUS
Privacy: 8



LINEN
Privacy: 8



MICRO-GRANITE
Privacy: 9



MISTIFY
Privacy: 6



RAIN
Privacy: 9



STREAMED
Privacy: 9

	GRID PATTERN	GLASS OPTIONS	TIMBERGRAIN CHERRY	TIMBERGRAIN FIR	TIMBERGRAIN KNOTTY ALDER	TIMBERGRAIN MAHOGANY	TIMBERGRAIN OAK
FIBERGLASS DOORS							
20	4L, 6L, 8L, 9LP	ALL 9 STYLES	●●			●●	●●
22	9LP, 10L, 15L	ALL 9 STYLES	●●		●●	●●	●●
25	4L, 8L, 9LP	ALL 9 STYLES			●		
25	6L	ALL 9 STYLES			●●●		
25	9L	ALL 9 STYLES			●●		
25P	4L, 8L, 9LP	ALL 9 STYLES			●		
25P	6L	ALL 9 STYLES			●●●		
25P	9L	ALL 9 STYLES			●●		
63	6L, 9L	ALL 9 STYLES	●●			●●	●●
201	4L, 6L, 8L	ALL 9 STYLES	●●				●●
201	9LP	ALL 9 STYLES	●●●				●●
201	10L, 15L	ALL 9 STYLES		●			
201P	4L, 6L, 8L	ALL 9 STYLES	●●				
201P	9LP	ALL 9 STYLES	●●●				
201P	10L, 15L	ALL 9 STYLES		●			
601	4L, 8L	CLEAR LOW-E, RAIN	●●				
601P	4L, 8L	CLEAR LOW-E, RAIN	●●				
608	4L, 8L	CLEAR LOW-E, RAIN	●●			●●	●●
648	4L	CLEAR LOW-E	●●			●●	●●
864	3L, 4L, 6L	CLEAR LOW-E, RAIN		●●●			
FIBERGLASS SIDELITES							
33	2L, 4L, 6LP	ALL 9 STYLES			●		
33	3L	ALL 9 STYLES	●●		●	●●	●●
38	2L, 3L, 4L	ALL 9 STYLES	●●			●●	●●
38	3LP	ALL 9 STYLES	●●			●	●
38	5L	ALL 9 STYLES		●			
38	6LP	ALL 9 STYLES	●●●			●●	●●
690	3LAC, 3LP	ALL 9 STYLES		●●			
690	5L, 6LP	ALL 9 STYLES	●●	●●	●●	●●	●●
820	2L, 2LP, 4L	CLEAR LOW-E, RAIN		●●			

Availability based on 3/0 width for doors and 14" for sidelites. ● 6/8 height ● 7/0 height ● 8/0 height
Other panel configurations and sizes may be available.



201-4LSDL



201-6LSDL



201-8LSDL



201-9LPSDL



201-10LSDL
8/0 height



201-15LSDL
8/0 height



201P

201P
8/0 height



20-4LSDL



20-6LSDL



20-8LSDL



20-9LPSDL



608-4LSDL



608-8LSDL



63-6LSDL



63-9LSDL



648-4LSDL



25-4LSDL
8/0 height



25-6LSDL



25-8LSDL
8/0 height



25-9LSDL



25-9LPSDL
8/0 height



25P

25P
8/0 height



22-9LPSDL



22-10LSDL



22-15LSDL



864-3LSDL
Option: dentil shelf



864-4LSDL



864-6LSDL

Other patterns available, refer to chart.



33-3LSDL



33-6LPSDL
8/0



38-4LSDL



38-5LSDL
8/0



690-3LPSDL



820-2LSDL



820-2LPSDL



820-4LSDL



Contemporary SIMULATED DIVIDED LITES

Contemporary SDL doors create a truly extraordinary front door that will enamor friends and family as they enter your home to create endless memories. Make a statement entry with these wider flat bars, available in 3.5" or 5.125" widths.

Glass Code: SDL

Privacy Rating: 1 6 8 9 10
TRANSPARENT OPAQUE

SOLID PANEL	TIMBERGRAIN FIR	PANEL WITH GLASS	TIMBERGRAIN FIR	SIDELITE	TIMBERGRAIN FIR
FIBERGLASS DOORS		FIBERGLASS DOORS		FIBERGLASS DOORS	
F822	●●	F822-G	●●	F822-G-SL	●●
F823	●●	F823-G	●●	F823-G-SL	●●
F824	●●	F824-G	●●	F824-G-SL	●●
F825	●●	F825-G	●●	F825-G-SL	●●
F826	●●	F826-G	●●	F826-G-SL	●●
F827	●●	F827-G	●●	F827-G-SL	●●
F828	●●	F828-G	●●	F828-G-SL	●●
F829	●●	F829-G	●●	F829-G-SL	●●
F862	●	F862-G	●		
F863	●	F863-G	●		
F864	●	F864-G	●		
F865	●	F865-G	●		
F866	●	F866-G	●		
F867	●	F867-G	●		
F868	●	F868-G	●		
F869	●	F869-G	●		

Availability based on 3/0 width for doors and 14" for sidelites.
 ● 6/8 height
 ● 7/0 height
 ● 8/0 height
 Other panel configurations and sizes may be available.

GLASS OPTIONS

SDL doors are available with Clear Low-E or your choice of privacy and textured glass.

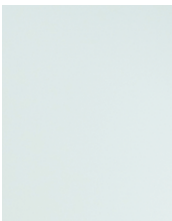

BLANCA
Privacy: 9

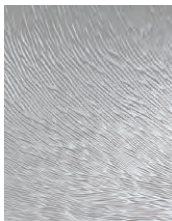

CHINCHILLA
Privacy: 9



CLEAR LOW-E
Privacy: 1



CUMULUS
Privacy: 8



LINEN
Privacy: 8



MICRO-GRANITE
Privacy: 9



MISTIFY
Privacy: 6



RAIN
Privacy: 9



STREAMED
Privacy: 9

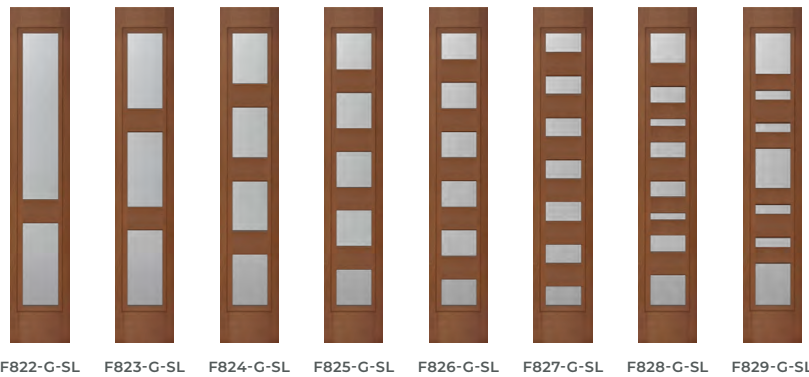

F822-G-SL F823-G-SL F824-G-SL F825-G-SL F826-G-SL F827-G-SL F828-G-SL F829-G-SL



F822



F823



F824



F825



F826

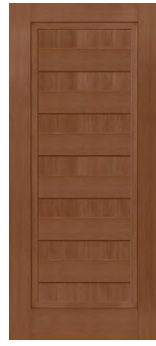

F827



F828



F829



F862
8/0 height



F863
8/0 height



F864
8/0 height



F865
8/0 height

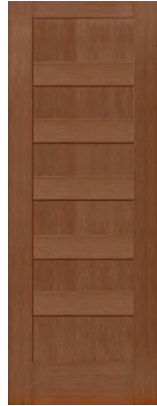

F866
8/0 height

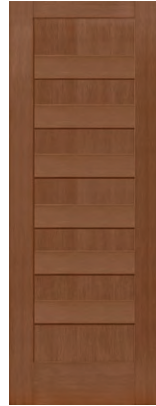

F867
8/0 height

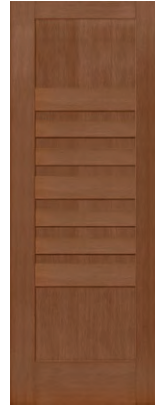

F868
8/0 height

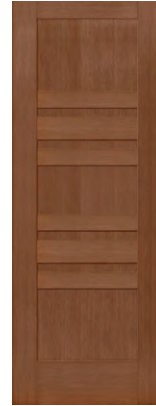

F869
8/0 height



F822-G



F823-G



F824-G



F825-G



F826-G



F827-G



F828-G



F829-G



F862-G
8/0 height



F863-G
8/0 height



F864-G
8/0 height



F865-G
8/0 height



F866-G
8/0 height



F867-G
8/0 height



F868-G
8/0 height



F869-G
8/0 height



201-4LSDL



201-4LHSDL
8/0 height



201-6LSDL



201-8LSDL



201-9LPSDL



201-10LSDL
8/0 height



201-12LSDL



201-15LSDL
8/0 height



20-4LSDL



20-4LHSDL
8/0 height



20-6LSDL



20-8LSDL



20-9LPSDL



20-10LSDL
8/0 height



20-12LSDL



20-15LSDL
8/0 height



22-4LSDL



22-4LHSDL



22-6LSDL



22-9LPSDL



22-10LSDL



22-12LSDL



22-15LSDL



23-4LSDL



23-5LSDL



69-2LSDL



69-3LSDL



69-3LPSDL



25-4LSDL



25-6LSDL



25-8LSDL
8/0 height



25-9LSDL



25-9LPSDL



25-12LSDL
8/0 height



25P-4LSDL



25P-6LSDL



25P-9LSDL



25P-9LPSDL



502S-4LSDL



502S-6LSDL



502S-9LSDL



502S-9LPSDL



63-4LSDL



63-6LSDL



63-8LSDL
8/0 height



63-9LSDL



63-9LPSDL



63-12LSDL
8/0 height



984F-4LSDL



984F-6LSDL



984F-8LSDL
8/0 height



984F-9LSDL



984F-9LPSDL



984F-12LSDL
8/0 height



Modern SIMULATED DIVIDED LITES

Clean, simple, everlasting. Focusing on grids that allow in natural light, Modern SDLs are the perfect complement to any home exterior with their sleek look.

Glass Code: SDL

Privacy Rating: 1 6 8 9 OPAQUE

	GRID PATTERN	CAMBRIDGE SMOOTH STEEL	WESTGUARD SMOOTH	NORWOOD TEXTURED	STEEL DOORS		FIBERGLASS DOORS	
865	2L, 3L, 4L, 6L						●	●
866	2L, 3L, 4L, 6L	● ●						
866F	2L, 3L, 4L, 6L	● ●	●	● ●				
866P	2L, 3L, 4L, 6L	● ●						

Availability based on 3/0 width for doors and 14" for sidelites. ● 6/8 height ● 7/0 height ● 8/0 height
Other panel configurations and sizes may be available.

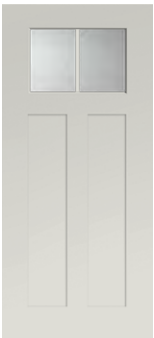

865-2LSDL

Option: dentil shelf



865-3LSDL

Option: dentil shelf



865-4LSDL

Option: dentil shelf



865-6LSDL

Option: dentil shelf



866-2LSDL

Option: dentil shelf



866-3LSDL

Option: dentil shelf



866-4LSDL

Option: dentil shelf



866-6LSDL

Option: dentil shelf



866F-2LSDL

Option: dentil shelf



866F-3LSDL

Option: dentil shelf



866F-4LSDL

Option: dentil shelf



866F-6LSDL

Option: dentil shelf



866P-2LSDL

Option: dentil shelf



866P-3LSDL

Option: dentil shelf



866P-4LSDL

Option: dentil shelf



866P-6LSDL

Option: dentil shelf



VENTED GLASS

Vents let you enjoy warm breezes when open, while shutting out cold wind and rain when closed. The UV-resistant frame keeps its appearance and the removable screen makes cleaning easy. With ten adjustment locations for latches, you have options for placement of the vent latch on the frame.

Privacy Rating: 1
 TRANSPARENT OPAQUE

*increase airflow in your home
with vented glass*

	CAMBRIDGE SMOOTH	WESTGUARD SMOOTH	NORWOOD TEXTURED	TRUGRAIN™	VALUENE	TIMBERLINE SMOOTH	TIMBERLINE TEXTURED FIR
	STEEL DOORS					FIBERGLASS DOORS	
2	● ●	●			●	●	
2-12L	● ●	●				●	
25	● ●	●	● ●			●	
25-12L	● ●	●	● ●			●	
61	● ●	●	● ●		●	●	
61-12	● ●	●	● ●		●	●	
984F	● ●	●	●	● ●		●	●
984F-12L	● ●	●	●	● ●		●	●

Availability based on 3/0 width for doors and 14" for sidelites.
 ● 6/8 height ● 7/0 height ● 8/0 height

Other panel configurations and sizes may be available.

Glass frame is White and is not paintable or stainable.

Available with Clear
or Low-E glass

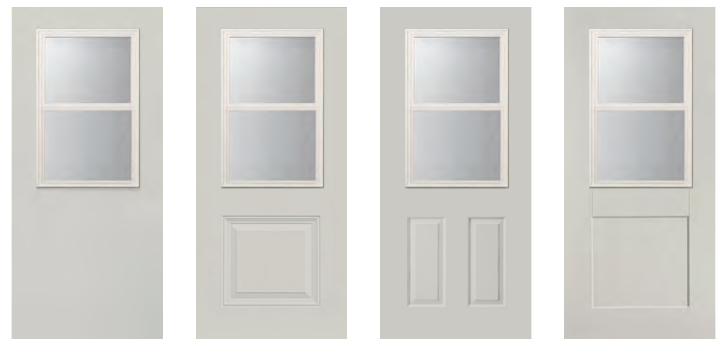

2V

25V

61V

984FV



2V-12L

25V-12L

61V-12L

984FV-12L



ENCLOSED BLINDS

Blinds enclosed between glass give you privacy and light control without dangling cords and endless dusting. Close your blinds for complete privacy and security or open them up to enjoy the outdoors. The levels of light and privacy are yours to control using our easy operator.

Glass Codes: RLBES, RLBTA, RLBSI, RLBSL, RLBWH



Privacy Rating:
 0 10
 TRANSPARENT OPAQUE

more privacy at night & increased sense of security



	COLOR	CAMBRIDGE SMOOTH	WESTGUARD SMOOTH	NORWOOD TEXTURED	TRUGRAIN™	VALUELINE	TIMBERLINE SMOOTH	TIMBERLINE TEXTURED FIR	TIMBERGRAIN CHERRY	TIMBERGRAIN FIR	TIMBERGRAIN KNOTTY ALDER	TIMBERGRAIN MAHOGANY	TIMBERGRAIN OAK
		STEEL DOORS						FIBERGLASS DOORS					
2	All	●●	●				●●						
502S	All	●●	●										
606	All						●		●				
	White	●●					●●		●●●				●●
606P	All								●				
607	All	●		●									
	White	●●		●●			●		●●			●●	●●
684	All	●●	●	●●	●●		●		●●			●●	●●
	Tan					●							
686	White	●●●	●●	●●●	●●●	●	●●		●●	●●	●●	●●	●●
	Tan & White					●							
984	All	●●	●	●●			●				●●		
	White	●●●	●●	●●●			●●				●●●		
984F	All	●●	●	●	●●		●	●					
	White	●●●	●●										
984P	All	●		●							●●		
STEEL SIDELITES						FIBERGLASS							
33	White	●●		●	●●		●		●●		●●	●●	●●

Availability based on 3/0 width for doors. ● 6/8 height ● 7/0 height ● 8/0 height
 Other panel configurations and sizes may be available.

COLOR OPTIONS

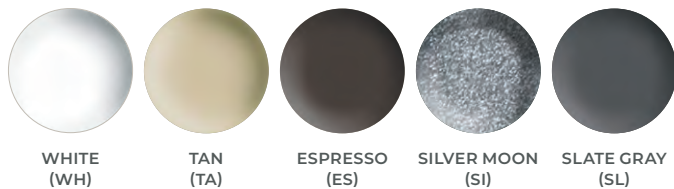

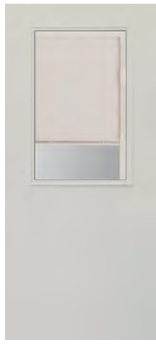

2



502S



606



606
8/0 height



606P
8/0 height



607



607
8/0 height



684



684
8/0 height



686



686
8/0 height



984



984
8/0 height



984F



984F
8/0 height



984P



33

- no dusting
- no cords
- safe for children & pets
- complete privacy





PRIVACY

Collection

Striking the right balance between privacy and security for your home's entry and a desired level of natural light can be tricky. Move the scale too far to one side, and you end up with a dark entryway, but move it too far to the other, and you end with too much visibility into your home. The Privacy glass collection offers a balance of the two. It filters glass for privacy without filtering light.



BLANCA

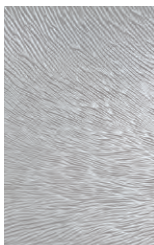

CHINCHILLA

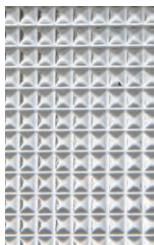

CUBED



CUMULUS

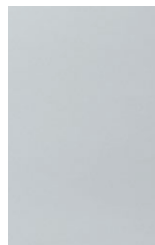

FROSTED



LINEN



MICRO-GRANITE

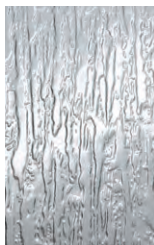

RAIN



STREAMED



VAPOR

design ————
 YOUR HOME

- + neutral color scheme with pops of color for doors and accent pieces
- + bold, simple patterns
- + statement outdoor lighting
- + greenery adds a warm welcome



BLANCA

Offering a high level of privacy and an understated backdrop, Blanca has a frosted, slightly stippled surface. The textured surface is enclosed in glass.

Glass Code: BLC

Privacy Rating: 9
TRANSPARENT OPAQUE

*an understated backdrop
in your foyer*

	CAMBRIDGE SMOOTH	WESTGUARD SMOOTH	NORWOOD TEXTURED	TRUGRAIN™	TIMBERLINE SMOOTH	TIMBERLINE TEXTURED FIR	TIMBERGRAIN CHERRY	TIMBERGRAIN FIR	TIMBERGRAIN KNOTTY ALDER	TIMBERGRAIN MAHOGANY	TIMBERGRAIN OAK
	STEEL DOORS					FIBERGLASS DOORS					
461C	●●	●	●●		●						
502S	●●	●									
606	●●				●●		●●●				●●
606P							●●●				
607	●●		●●●		●		●●			●●	●●
684	●●●	●●	●●●	●●●	●●		●●			●●	●●
686	●●●	●●	●●●	●●●	●●●	●	●●		●●	●●	●●
692	●●	●	●●	●●	●						
694	●●●	●●	●●●	●●	●●						
694-1	●●●	●●	●●	●●	●●						
865					●	●					
866	●●										
866F	●●	●	●	●●							
866P	●										
984	●●●	●●	●●●		●●				●●●		
984F	●●●	●●	●	●●	●	●					
984P	●		●						●●●		
	STEEL SIDELITES					FIBERGLASS SIDELITES					
422	●				●		●●●			●●	●●
690							●●	●●	●●	●●	●●
692	●		●	●●	●		●●●		●●●	●●	●●
694	●●●		●●●	●●●	●●●						

Availability based on 3/0 width for doors and 14" for sidelites. ● 6/8 height ● 7/0 height ● 8/0 height
Other panel configurations and sizes may be available.





461C



502S



606



606
8/0 height



606P



606P
8/0 height



607



607
8/0 height



684



684
8/0 height

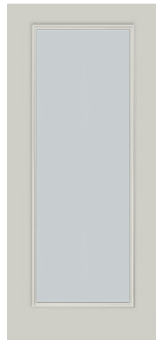

686



686
8/0 height



692



694



694
8/0 height

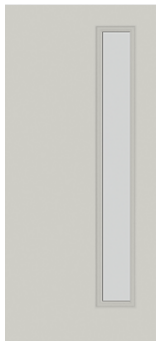

694-1
left or right



694-1
8/0 height
left or right



865
Option: dentil shelf



866
Option: dentil shelf



866F
Option: dentil shelf
(Cambridge & Norwood)



866P
Option: dentil shelf



984



984
8/0 height



984F



984F
8/0 height



984P



984P
8/0 height



422



422
8/0



690



692



692
8/0



694



694
8/0



CHINCHILLA

As touchable as its namesake, Chinchilla's fine lines and organic, fur-like texture create a striking wave pattern when seen from afar. It offers a high level of privacy with the textured glass surface exposed to the inside of the home.

Glass Code: CHA

Privacy Rating: 9
TRANSPARENT OPAQUE

	CAMBRIDGE SMOOTH	WESTGUARD SMOOTH	NORWOOD TEXTURED	TRUGRAIN™	TIMBERLINE SMOOTH	TIMBERLINE TEXTURED FIR	TIMBERGRAIN CHERRY	TIMBERGRAIN FIR	TIMBERGRAIN KNOTTY ALDER	TIMBERGRAIN MAHOGANY	TIMBERGRAIN OAK
	STEEL DOORS					FIBERGLASS DOORS					
461C	●●	●	●●		●						
502S	●●	●									
606	●●				●●		●●				●●
606P							●●				
607	●●		●●		●		●●			●●	●●
651	●●●	●●	●●●	●●●	●●●						
651A	●●●	●●	●●●	●●●	●●●						
651B-1	●●	●									
651B-2	●●	●									
651B-12	●●	●									
651B-23	●●	●									
651B-24	●●	●									
651B-123	●●	●									
651B-135	●●	●									
651B-1234	●●	●									
651B-55	●●	●			●●						
684	●●●	●●	●●●	●●●	●●		●●			●●	●●
686	●●●	●●	●●●	●●●	●●●	●	●●	●●	●●	●●	●●
692	●●	●	●●	●●	●						
694	●●	●	●●	●	●						
694-1	●●●	●●	●●	●●	●●						
840	●●●	●●	●●●	●●●	●●●						

creates a striking wave pattern when seen from afar



Availability based on 3/0 width for doors and 14" for sidelites.
 ● 6/8 height ● 7/0 height ● 8/0 height
 Other panel configurations and sizes may be available.



461C



502S



606



606
8/0 height



606P



606P
8/0 height



607



607
8/0 height



651



651
8/0 height

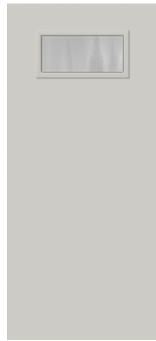

651A

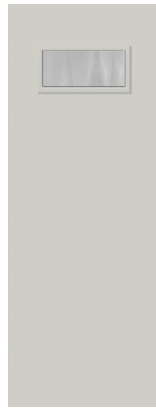

651A
8/0 height



651B-1



651B-2



651B-12



651B-23



651B-24



651B-123



651B-135



651B-1234



651B-55



684



684
8/0 height



686



686
8/0 height



692



694



694-1
left or right



694-1
left or right
8/0 height

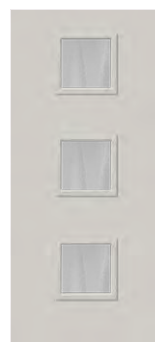

840



840
8/0 height

Additional panels
and sidelites on
following page.



CHINCHILLA

As touchable as its namesake, Chinchilla's fine lines and organic, fur-like texture create a striking wave pattern when seen from afar. It offers a high level of privacy with the textured glass surface exposed to the inside of the home.

Glass Code: CHA

Privacy Rating: 9
TRANSPARENT OPAQUE

creates a striking wave pattern when seen from afar



	CAMBRIDGE SMOOTH	WESTGUARD SMOOTH	NORWOOD TEXTURED	TRUGRAIN™	TIMBERLINE SMOOTH	TIMBERLINE TEXTURED FIR	TIMBERGRAIN CHERRY	TIMBERGRAIN FIR	TIMBERGRAIN KNOTTY ALDER	TIMBERGRAIN MAHOGANY	TIMBERGRAIN OAK
	STEEL DOORS					FIBERGLASS DOORS					
840A	●●●	●●	●●●	●●●	●●●						
842	●●●	●●	●●●	●●●	●●●						
842A	●●●	●●	●●●	●●●	●●●						
843	●●●	●●	●●●	●●●	●●●						
843A	●●●	●●	●●●	●●●	●●●						
843B	●●●	●●	●●●	●●●	●●●						
865					●	●					
866	●●										
866F	●●	●	●	●●							
866P	●										
984	●●●	●●	●●●		●●				●●●		
984F	●●●	●●	●	●●	●	●					
984P	●		●						●●●		
	STEEL SIDELITES					FIBERGLASS SIDELITES					
105	●●		●●	●●	●						
422	●				●		●●●			●●	●●
690							●●	●●	●●	●●	●●
692	●		●●	●●	●		●●		●●	●●	●●
694	●●●		●●●	●●●	●●●						

Availability based on 3/0 width for doors and 14" for sidelites. ● 6/8 height ● 7/0 height ● 8/0 height
Other panel configurations and sizes may be available.



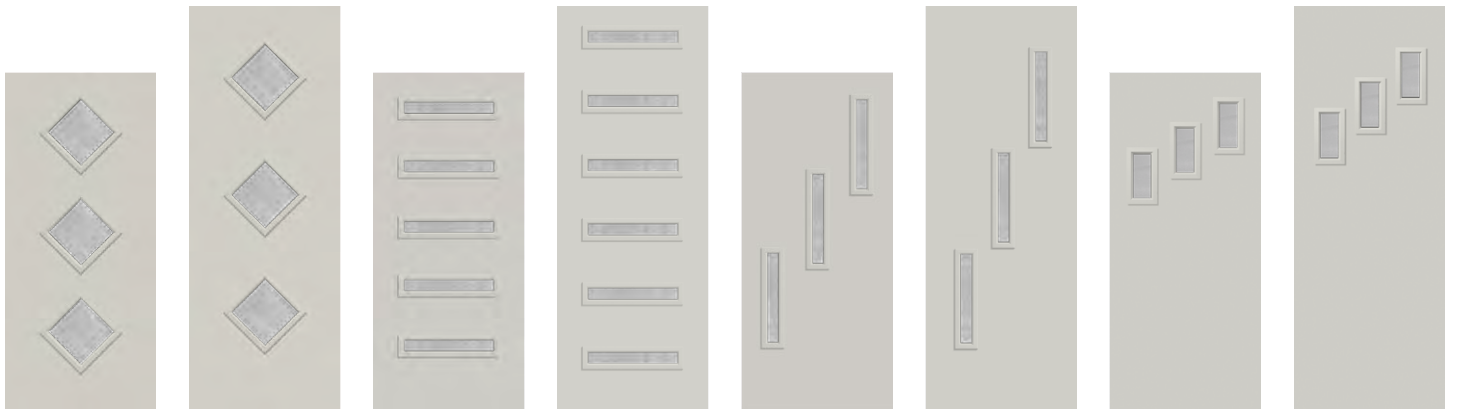

840A

840A
8/0 height

842

842
8/0 height

842A
left or right

842A
left or right
8/0 height

843
left or right

843
left or right
8/0 height

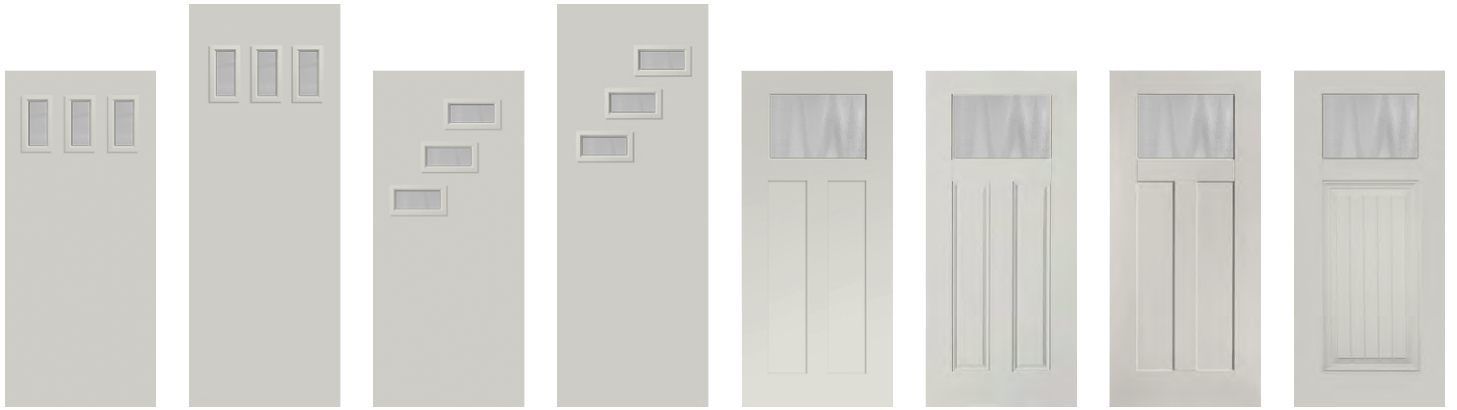

843A

843A
8/0 height

843B
left or right

843B
left or right
8/0 height

865
Option: dentil shelf

866
Option: dentil shelf

866F
Option: dentil shelf
(Cambridge & Norwood)

866P
Option: dentil shelf



984

984
8/0 height

984F

984F
8/0 height

984P

984P
8/0 height

Additional configurations shown on previous page.



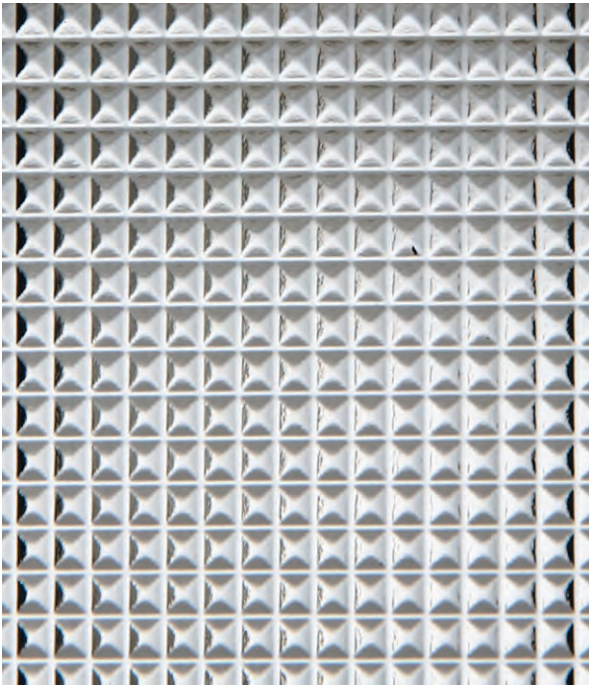

CUBED

Cubed glass brings to life the symmetry and geometric patterns found in the architecture of the 1920s and 1930s. Grid patterns, glass blocks, and structure are celebrated in this glass style.

Glass Code: CBD

Privacy Rating: 9
TRANSPARENT OPAQUE

symmetry creates an eye-catching design



	CAMBRIDGE SMOOTH	WESTGUARD SMOOTH	NORWOOD TEXTURED	TRUGRAIN™	TIMBERLINE SMOOTH
	STEEL DOORS				FIBERGLASS DOORS
651	●●●	●●	●●●	●●●	●●●
651A	●●●	●●	●●●	●●●	●●●
651B-1	●●	●			
651B-2	●●	●			
651B-12	●●	●			
651B-23	●●	●			
651B-24	●●	●			
651B-123	●●	●			
651B-135	●●	●			
651B-1234	●●	●			
651B-55	●●	●			●●
694-1	●●	●	●●	●●	●●
840	●●●	●●	●●●	●●●	●●●
840A	●●●	●●	●●●	●●●	●●●
842	●●●	●●	●●●	●●●	●●●
842A	●●●	●●	●●●	●●●	●●●
843	●●●	●●	●●●	●●●	●●●
843A	●●●	●●	●●●	●●●	●●●
843B	●●●	●●	●●●	●●●	●●●
	STEEL SIDELITES				FIBERGLASS SIDELITES
105	●●		●●	●●	●

Availability based on 3/0 width for doors and 14" for sidelites.

- 6/8 height
- 7/0 height
- 8/0 height

Other panel configurations and sizes may be available.



651



651
8/0 height

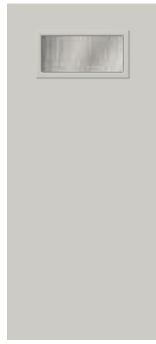

651A

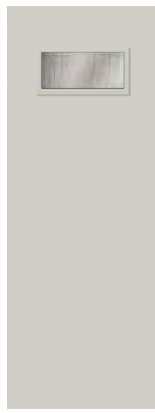

651A
8/0 height



651B-1



651B-2



651B-12



651B-23



651B-24



651B-123



651B-135



651B-1234



651B-55



694-1
left or right



840

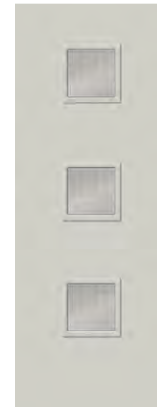

840
8/0 height



840A



840A
8/0 height



842



842
8/0 height



842A
left or right



842A
left or right
8/0 height



843
left or right



843
left or right
8/0 height



843A

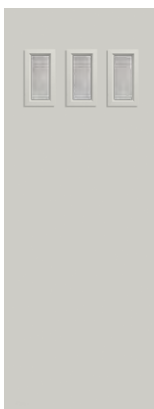

843A
8/0 height



843B
left or right



843B
left or right
8/0 height



105



CUMULUS

Whether soft wisps of clouds or a 30,000-foot view of mountainous terrain, Cumulus takes a view from afar and brings it down to earth in your entryway. The textured glass surface is exposed to the inside of the home.

Glass Code: CMS

Privacy Rating:  8
TRANSPARENT OPAQUE

*the delightful feeling
of being in the clouds*



	CAMBRIDGE SMOOTH	WESTGUARD SMOOTH	NORWOOD TEXTURED	TRUGRAIN™	TIMBERLINE SMOOTH	TIMBERLINE TEXTURED FIR	TIMBERGRAIN CHERRY	TIMBERGRAIN FIR	TIMBERGRAIN KNOTTY ALDER	TIMBERGRAIN MAHOGANY	TIMBERGRAIN OAK
	STEEL DOORS					FIBERGLASS DOORS					
461C	●●	●	●●		●						
502S	●●	●									
606	●●				●●		●●●				●●
606P							●●●				
607	●●		●●●		●		●●			●●	●●
684	●●●	●●	●●●	●●●	●●		●●			●●	●●
686	●●●	●●	●●●	●●●	●●●	●	●●	●●●	●●	●●	●●
692	●●	●	●●	●●	●						
694	●●●	●●	●●●	●●	●●						
694-1	●●●	●●	●●	●●	●●						
865					●	●					
866	●●										
866F	●●	●	●	●●							
866P	●										
984	●●●	●●	●●●		●●				●●●		
984F	●●●	●●	●	●●	●	●					
984P	●		●						●●●		
	STEEL SIDELITES					FIBERGLASS SIDELITES					
422	●				●		●●●			●●	●●
690							●●	●●	●●	●●	●●
692	●		●	●●	●		●●●		●●●	●●	●●
694	●●●		●●●	●●●	●●●						

Availability based on 3/0 width for doors and 14" for sidelites.
 ● 6/8 height ● 7/0 height ● 8/0 height
 Other panel configurations and sizes may be available.



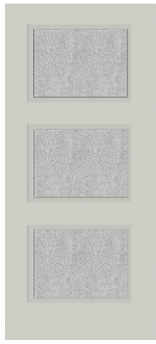

461C



502S



606



606
8/0 height



606P



606P
8/0 height



607



607
8/0 height



684



684
8/0 height



686



686
8/0 height



692



694



694
8/0 height



694-1
left or right



694-1
8/0 height
left or right



865
Option: dentil shelf



866
Option: dentil shelf



866F
Option: dentil shelf
(Cambridge & Norwood)



866P
Option: dentil shelf



984



984
8/0 height



984F



984F
8/0 height



984P



984P
8/0 height



422



422
8/0



690



692



692
8/0



694



694
8/0

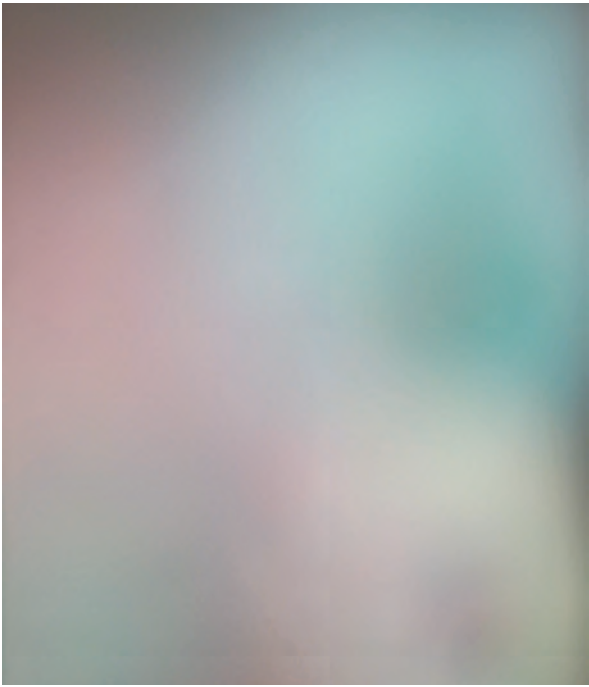

FROSTED

Frosted glass blends privacy with natural light, something that will find itself at home in any architectural style. The translucent look allows light through while still offering a high level of privacy.

Glass Code: FSB

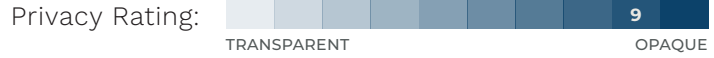

great choice for those who prefer simple elegant décor



	CAMBRIDGE SMOOTH	WESTGUARD SMOOTH	NORWOOD TEXTURED	TRUGRAIN™	TIMBERLINE SMOOTH
	STEEL DOORS				FIBERGLASS DOORS
651	●●●	●●	●●●	●●●	●●●
651A	●●●	●●	●●●	●●●	●●●
651B-1	●●	●			
651B-2	●●	●			
651B-12	●●	●			
651B-23	●●	●			
651B-24	●●	●			
651B-123	●●	●			
651B-135	●●	●			
651B-1234	●●	●			
651B-55	●●	●			●●
694-1	●●	●	●●	●●	●●
840	●●●	●●	●●●	●●●	●●●
840A	●●●	●●	●●●	●●●	●●●
842	●●●	●●	●●●	●●●	●●●
842A	●●●	●●	●●●	●●●	●●●
843	●●●	●●	●●●	●●●	●●●
843A	●●●	●●	●●●	●●●	●●●
843B	●●●	●●	●●●	●●●	●●●
	STEEL SIDELITES				FIBERGLASS SIDELITES
105	●●		●●	●●	●

Availability based on 3/0 width for doors and 14" for sidelites.

- 6/8 height
- 7/0 height
- 8/0 height

Other panel configurations and sizes may be available.





651

651
8/0 height

651A

651A
8/0 height

651B-1

651B-2

651B-12

651B-23



651B-24

651B-123

651B-135

651B-1234

651B-55

694-1
left or right

840

840
8/0 height

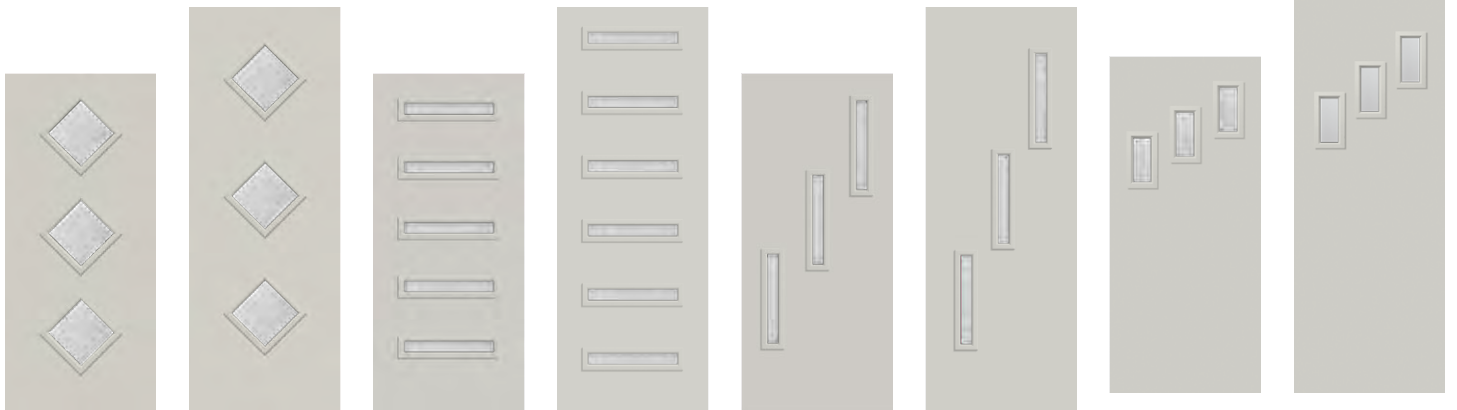

840A

840A
8/0 height

842

842
8/0 height

842A
left or right

842A
left or right
8/0 height

843
left or right

843
left or right
8/0 height

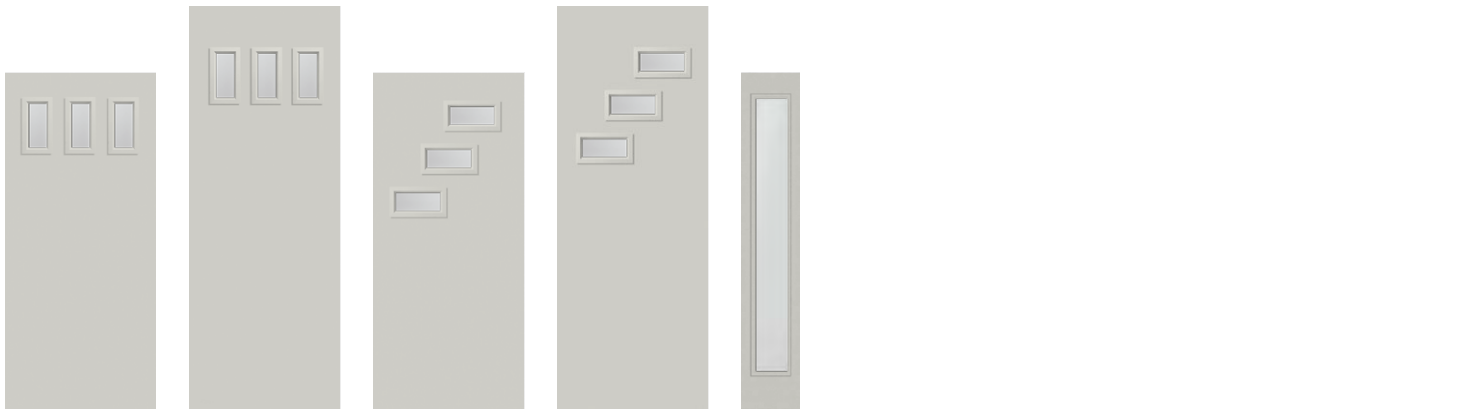

843A

843A
8/0 height

843B
left or right

843B
left or right
8/0 height

105



LINEN

Whether reminiscent of a soft linen shirt or an elegantly embroidered linen tablecloth, Linen's lightly etched glass and woven pattern complement casual or formal entryway designs. The translucent white glass and soft moiré of Linen's threads give it a high privacy level. Textured surface exposed to the inside of the home.

Glass Code: LNN

Privacy Rating: 9
TRANSPARENT OPAQUE

complements casual & formal entryways



	CAMBRIDGE SMOOTH	WESTGUARD SMOOTH	NORWOOD TEXTURED	TRUGRAIN™	TIMBERLINE SMOOTH	TIMBERLINE TEXTURED FIR	TIMBERGRAIN CHERRY	TIMBERGRAIN FIR	TIMBERGRAIN KNOTTY ALDER	TIMBERGRAIN MAHOGANY	TIMBERGRAIN OAK
	STEEL DOORS					FIBERGLASS DOORS					
461C	●●	●	●●		●						
606	●●				●		●●●				●●
606P							●●●				
607	●●		●●●		●		●●			●●	●●
684	●●●	●●	●●●	●●●	●●		●●			●●	●●
686	●●●	●●	●●●	●●●	●●●	●	●●	●●●	●●	●●	●●
694	●●	●	●●	●	●						
694-1	●●●	●●	●●	●●	●●						
865					●	●					
866	●●										
866F	●●	●	●	●●							
866P	●										
984	●●●	●●	●●●		●●				●●●		
984F	●●●	●●	●	●●	●	●					
984P	●		●						●●●		
	STEEL SIDELITES					FIBERGLASS SIDELITES					
422	●				●		●●●			●●	●●
690							●●	●●	●●	●●	●●
692	●		●●	●●	●		●●●		●●●	●●	●●
694	●●●		●●●	●●●	●●●						

Availability based on 3/0 width for doors and 14" for sidelites. ● 6/8 height ● 7/0 height ● 8/0 height
Other panel configurations and sizes may be available.



461C

606

606
8/0 height

606P

606P
8/0 height

607

607
8/0 height



684

684
8/0 height

686

686
8/0 height

694

694-1
left or right

694-1
8/0 height
left or right



865

Option: dentil shelf

866

Option: dentil shelf

866F

Option: dentil shelf
(Cambridge & Norwood)

866P

Option: dentil shelf

984

984
8/0 height



984F

984F
8/0 height

984P

984P
8/0 height

422

422
8/0

690

692

692
8/0

694

694
8/0



MICRO-GRANITE

Just as its name implies, Micro-Granite blends texture and pattern to create a surface reminiscent of small, textured, polished pebbles. It offers a high level of privacy with the textured surface enclosed in glass.

Glass Code: MG

Privacy Rating:  9
TRANSPARENT OPAQUE

offers texture & a high privacy level



	CAMBRIDGE SMOOTH	WESTGUARD SMOOTH	NORWOOD TEXTURED	TRUCRAIN™	TIMBERLINE SMOOTH	TIMBERLINE TEXTURED FIR	TIMBERGRAIN CHERRY	TIMBERGRAIN FIR	TIMBERGRAIN KNOTTY ALDER	TIMBERGRAIN MAHOGANY	TIMBERGRAIN OAK
	STEEL DOORS					FIBERGLASS DOORS					
461C	●●	●	●●		●						
502S	●●	●									
606	●●				●●		●●●				●●
606P							●●●				
607	●●		●●●		●		●●			●●	●●
684	●●●	●●	●●●	●●●	●●		●●			●●	●●
686	●●●	●●	●●●	●●●	●●	●	●●	●●●	●●	●●	●●
692	●●	●	●●	●●	●						
694	●●●	●●	●●●	●●	●●						
694-1	●●●	●●	●●	●●	●●						
865					●	●					
866	●●										
866F	●●	●	●	●●							
866P	●										
984	●●●	●●	●●●		●●				●●●		
984F	●●●	●●	●	●●	●	●					
984P	●		●						●●●		
	STEEL SIDELITES					FIBERGLASS SIDELITES					
422	●				●		●●●			●●	●●
690							●●	●●	●●	●●	●●
692	●		●	●●	●		●●●		●●●	●●	●●
694	●●●		●●●	●●●	●●●						

Availability based on 3/0 width for doors and 14" for sidelites. ● 6/8 height ● 7/0 height ● 8/0 height
Other panel configurations and sizes may be available.



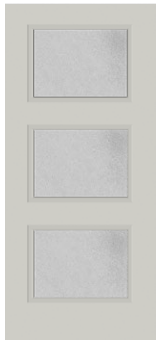

461C



502S



606



606
8/0 height



606P



606P
8/0 height



607



607
8/0 height



684



684
8/0 height



686



686
8/0 height



692



694

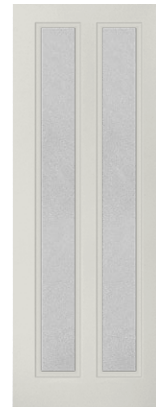

694
8/0 height



694-1
left or right



694-1
8/0 height
left or right



865
Option: dentil shelf



866
Option: dentil shelf



866F
Option: dentil shelf
(Cambridge & Norwood)



866P
Option: dentil shelf



984



984
8/0 height



984F



984F
8/0 height



984P



984P
8/0 height



422



422
8/0



690



692



692
8/0



694



694
8/0



RAIN

All that's missing is the patter of raindrops. Rain features a vertical pattern and textured surface that creates the illusion of rain trickling down a window. It offers a high level of privacy with the textured surface enclosed in glass.

Glass Code: RN

Privacy Rating: 9
 TRANSPARENT OPAQUE

brings a high level of privacy to a home



	CAMBRIDGE SMOOTH	WESTGUARD SMOOTH	NORWOOD TEXTURED	TRUGRAIN™	VALLELINE SMOOTH	TIMBERLINE SMOOTH	TIMBERLINE TEXTURED FIR	TIMBERGRAIN CHERRY	TIMBERGRAIN FIR	TIMBERGRAIN KNOTTY ALDER	TIMBERGRAIN MAHOGANY	TIMBERGRAIN OAK
	STEEL DOORS						FIBERGLASS DOORS					
2					●							
41					●							
461C	●●	●	●●			●						
502S	●●	●										
606	●●					●●		●●●				●●
606P								●●●				
607	●●		●●●			●		●●			●●	●●
651	●●●	●●	●●●	●●●		●●●						
651A	●●●	●●	●●●	●●●		●●●						
651B-1	●●	●										
651B-2	●●	●										
651B-12	●●	●										
651B-23	●●	●										
651B-24	●●	●										
651B-123	●●	●										
651B-135	●●	●										
651B-1234	●●	●										
651B-55	●●	●				●●						
659	●●		●●		●	●						
680	●●	●	●●	●●	●	●						
684	●●●	●●	●●●	●●●	●	●●		●●			●●	●●
686	●●●	●●	●●●	●●●	●	●●●	●	●●	●●●	●●	●●	●●
692	●●	●	●●	●●	●	●						
694	●●●	●●	●●●	●●		●●						

Availability based on 3/0 width for doors and 14" for sidelites. ● 6/8 height ● 7/0 height ● 8/0 height
 Other panel configurations and sizes may be available.

Additional panels and sidelites on following page.

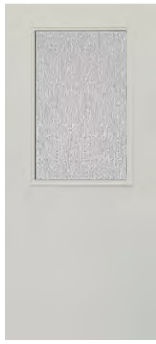

2



41



461C



502S



606



606
8/0 height



606P



606P
8/0 height



607



607
8/0 height



651



651
8/0 height

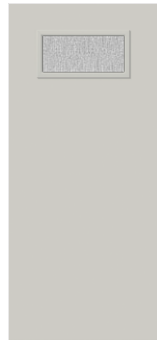

651A



651A
8/0 height



651B-1



651B-2



651B-12



651B-23



651B-24



651B-123



651B-135



651B-1234



651B-55



659



680



684



684
8/0 height



686



686
8/0 height



692



694



694
8/0 height 87



RAIN

All that's missing is the patter of raindrops. Rain features a vertical pattern and textured surface that creates the illusion of rain trickling down a window. It offers a high level of privacy with the textured surface enclosed in glass.

Glass Code: RN

Privacy Rating: 9
TRANSPARENT OPAQUE

	CAMBRIDGE SMOOTH	WESTGUARD SMOOTH	NORWOOD TEXTURED	TRUGRAIN™	VALUELINE SMOOTH	TIMBERLINE SMOOTH	TIMBERLINE TEXTURED FIR	TIMBERGRAIN CHERRY	TIMBERGRAIN FIR	TIMBERGRAIN KNOTTY ALDER	TIMBERGRAIN MAHOGANY	TIMBERGRAIN OAK
	STEEL DOORS						FIBERGLASS DOORS					
694-1	●●●	●●	●●	●●		●●						
840	●●●	●●	●●	●●		●●						
840A	●●●	●●	●●	●●		●●						
842	●●●	●●	●●	●●		●●						
842A	●●●	●●	●●	●●		●●						
843	●●●	●●	●●	●●		●●						
843A	●●●	●●	●●	●●		●●						
843B	●●●	●●	●●	●●		●●						
864								●●●				
865						●	●					
866	●●				●							
866F	●●	●	●	●●								
866P	●											
937A								●●				
937C								●●			●●	●●
984	●●●	●●	●●		●	●				●●●		
984F	●●●	●●	●	●●		●	●					
984P	●		●							●●●		
	STEEL SIDELITES						FIBERGLASS SIDELITES					
5 (direct set)	●●●	●●	●●	●●	●●	●●	●●	●●	●●	●●	●●	●●
105	●●		●●	●●		●						
422	●							●●●			●●	●●
690								●●	●●	●●	●●	●●
692	●●		●	●●		●		●●●		●●●	●●	●●
694	●●●		●●	●●		●●						
820								●●				

Availability based on 3/0 width for doors and 14" for sidelites. ● 6/8 height ● 7/0 height ● 8/0 height
Other panel configurations and sizes may be available.

Additional configurations shown on previous page.





694-1
left or right



694-1
8/0 height
left or right



840

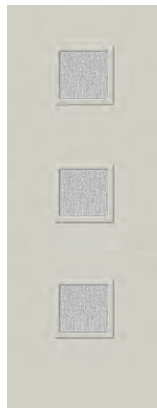

840
8/0 height



840A



840A
8/0 height



842



842
8/0 height



842A
left or right

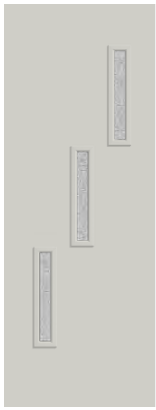

842A
left or right
8/0 height



843
left or right



843
left or right
8/0 height



843A



843A
8/0 height



843B
left or right



843B
left or right
8/0 height



864
Option: dentil shelf



864
8/0 height
Option: dentil shelf



865
Option: dentil shelf



866
Option: dentil shelf



866F
Option: dentil shelf
(Cambridge & Norwood)



866P
Option: dentil shelf



937A



937C



984



984
8/0 height



984F



984F
8/0 height



984P



984P
8/0 height

STREAMED

The pronounced vertical pattern and strong ribbed texture creates the illusion of the organic flow of water in your entryway. Offers a high level of privacy. The textured glass surface is exposed to the inside of the home.

Glass Code: STM

Privacy Rating:  9
TRANSPARENT OPAQUE



a vertical pattern with a ribbed texture



	CAMBRIDGE SMOOTH	WESTGUARD SMOOTH	NORWOOD TEXTURED	TRUGRAIN™	TIMBERLINE SMOOTH	TIMBERLINE TEXTURED FIR	TIMBERGRAIN CHERRY	TIMBERGRAIN FIR	TIMBERGRAIN KNOTTY ALDER	TIMBERGRAIN MAHOGANY	TIMBERGRAIN OAK
	STEEL DOORS					FIBERGLASS DOORS					
461C	●●	●	●●		●						
502S	●●	●									
606	●●				●●		●●●				●●
606P							●●●				
607	●●		●●●		●		●●			●●	●●
684	●●●	●●	●●●	●●●	●●		●●			●●	●●
686	●●●	●●	●●●	●●●	●●●	●	●●	●●●	●●	●●	●●
692	●●	●	●●	●●	●						
694	●●●	●●	●●●	●●	●●						
694-1	●●●	●●	●●	●●	●●						
865					●	●					
866	●●										
866F	●●	●	●	●●							
866P	●										
984	●●●	●●	●●●		●●			●●●			
984F	●●●	●●	●	●●	●	●					
984P	●		●					●●●			
	STEEL SIDELITES					FIBERGLASS SIDELITES					
422	●				●		●●●			●●	●●
690							●●	●●	●●	●●	●●
692	●		●	●●	●		●●●		●●	●●	●●
694	●●●		●●●	●●●	●●●						

Availability based on 3/0 width for doors and 14" for sidelites.
 ● 6/8 height ● 7/0 height ● 8/0 height
 Other panel configurations and sizes may be available.



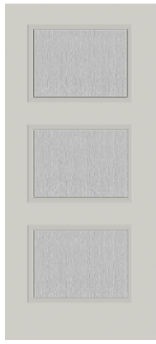

461C



502S



606



606
8/0 height



606P



606P
8/0 height



607



607
8/0 height



684



684
8/0 height



686



686
8/0 height



692



694

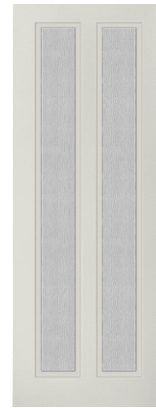

694
8/0 height



694-1
left or right



694-1
8/0 height
left or right



865
Option: dentil shelf



866
Option: dentil shelf



866F
Option: dentil shelf
(Cambridge & Norwood)



866P
Option: dentil shelf



984



984
8/0 height



984F



984F
8/0 height



984P



984P
8/0 height



422



422
8/0



690



692



692
8/0



694





694
8/0



VAPOR

Reminiscent of the Northern Lights, Vapor creates an ethereal play of light and shadow and a medium level of privacy for your entryway. The textured glass surface is exposed to the inside of the home.

Glass Code: VPR

Privacy Rating:  6  TRANSPARENT OPAQUE

a stunning display of light and shadows



	CAMBRIDGE SMOOTH	WESTGUARD SMOOTH	NORWOOD TEXTURED	TRUGRAIN™	TIMBERLINE SMOOTH	TIMBERLINE TEXTURED FIR	TIMBERGRAIN CHERRY	TIMBERGRAIN FIR	TIMBERGRAIN KNOTTY ALDER	TIMBERGRAIN MAHOGANY	TIMBERGRAIN OAK
	STEEL DOORS					FIBERGLASS DOORS					
461C	●●	●	●●		●						
502S	●●	●									
606	●●				●●		●●●				●●
606P							●●●				
607	●●		●●●		●		●●			●●	●●
684	●●●	●●	●●●	●●●	●●		●●			●●	●●
686	●●●	●●	●●●	●●●	●●●	●	●●	●●●	●●	●●	●●
692	●●	●	●●	●●	●						
694	●●●	●●	●●●	●●	●●						
694-1	●●●	●●	●●	●●	●●						
865					●	●					
866	●●										
866F	●●	●	●	●●							
866P	●										
984	●●●	●●	●●●		●●				●●●		
984F	●●●	●●	●	●●	●	●					
984P	●		●						●●●		
	STEEL SIDELITES					FIBERGLASS SIDELITES					
422	●				●		●●●			●●	●●
690							●●	●●	●●	●●	●●
692	●		●	●●	●		●●●		●●	●●	●●
694	●●●		●●●	●●●	●●●						

Availability based on 3/0 width for doors and 14" for sidelites.
 ● 6/8 height ● 7/0 height ● 8/0 height
 Other panel configurations and sizes may be available.





461C



502S



606



606
8/0 height



606P



606P
8/0 height



607



607
8/0 height



684



684
8/0 height



686



686
8/0 height



692



694



694
8/0 height

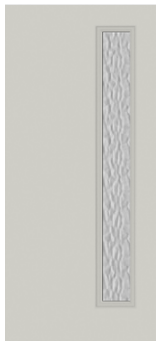

694-1
left or right



694-1
8/0 height
left or right



865
Option: dentil shelf



866
Option: dentil shelf



866F
Option: dentil shelf
(Cambridge & Norwood)



866P
Option: dentil shelf



984



984
8/0 height



984F



984F
8/0 height



984P



984P
8/0 height

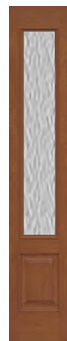

422



422
8/0



690

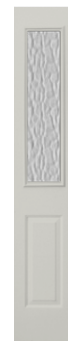

692



692
8/0



694



694
8/0



CRAFTSMAN

Collection

Simple designs inspired by nature are the hallmarks of the Craftsman style. These beautiful geometric designs cast intricate patterns of sunlight into the interior spaces of your home. Handcrafted glass honors the Craftsman reverence for fine material with coming options that blend beautifully with finishes inside and outside the home.



TOPAZ

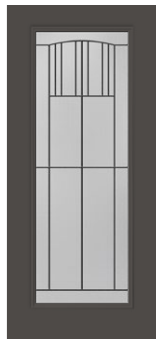

MADISON

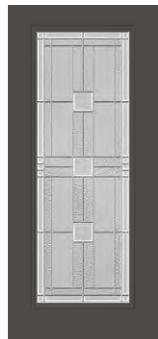

MONTEREY

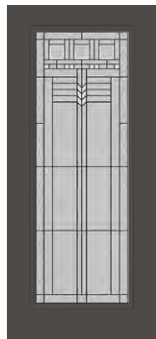

HEARTLAND

design ———
└───┬───┐
YOUR HOME

- + natural, earth-tone color palette
- + rich woods & stone details
- + board & batten walls
- + column-heavy front porches
- + thick trim and molding profiles



502S



601



601P



606

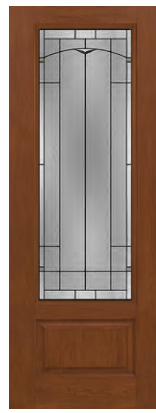

606
8/0 height



606P



606P
8/0 height



607

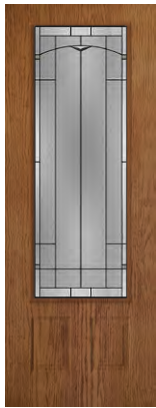

607
8/0 height



608



648



684



684
8/0 height



686



692

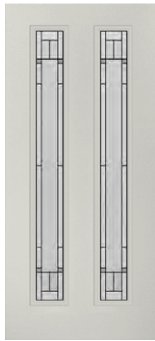

694

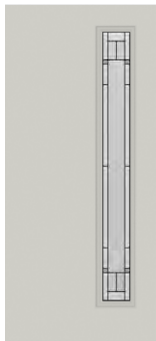

694-1
left or right

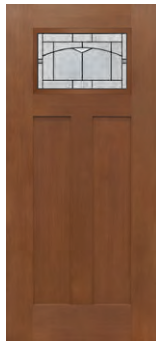

864
Option: dentil shelf



865
Option: dentil shelf



866
Option: dentil shelf



866F
Option: dentil shelf
(Cambridge & Norwood)



866P
Option: dentil shelf



973
8/0 height



973P
8/0 height



984

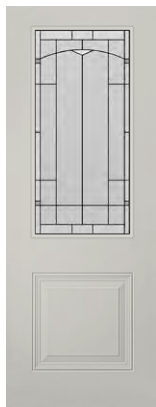

984
8/0 height



984F

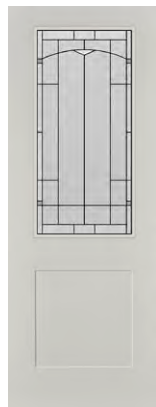

984F
8/0 height



984P



984P
8/0 height



complements the special touches of your home



MADISON

The Craftsman-inspired design of Madison's geometric pattern and its nickel vein wrought iron finish will fit the surrounding landscape of your home and complement the special touches you've given it. Madison provides a high privacy level.

Nickel Vein Wrought Iron  Glass Code: MDS

Privacy Rating:  9
TRANSPARENT OPAQUE

	CAMBRIDGE SMOOTH	WESTGUARD SMOOTH	NORWOOD TEXTURED	TRUGRAIN™	TIMBERLINE SMOOTH	TIMBERLINE TEXTURED FIR	TIMBERGRAIN CHERRY	TIMBERGRAIN FIR	TIMBERGRAIN KNOTTY ALDER	TIMBERGRAIN MAHOGANY	TIMBERGRAIN OAK
	STEEL DOORS					FIBERGLASS DOORS					
606					●●		●●●				●●
606P							●●●				
607	●●		●●●		●		●●			●●	●●
684	●	●	●	●	●						
686	●●●	●●	●●●	●●●	●●●	●	●●	●●●	●●	●●	●●
694	●●●	●●	●●●	●●	●●						
694-1	●●●	●●	●●	●●	●●						
984	●	●	●		●				●		
984F	●	●									
984P									●		
	STEEL SIDELITES					FIBERGLASS SIDELITES					
422	●		●		●		●●●			●●	●●
690							●●	●●	●●	●●	●●
692							●		●		
694	●●●		●●●	●●●	●●●						

Availability based on 3/0 width for doors and 14" for sidelites. ● 6/8 height ● 7/0 height ● 8/0 height
Other panel configurations and sizes may be available.





606

606
8/0 height

606P

606P
8/0 height

607

607
8/0 height

684
8/0 height

686

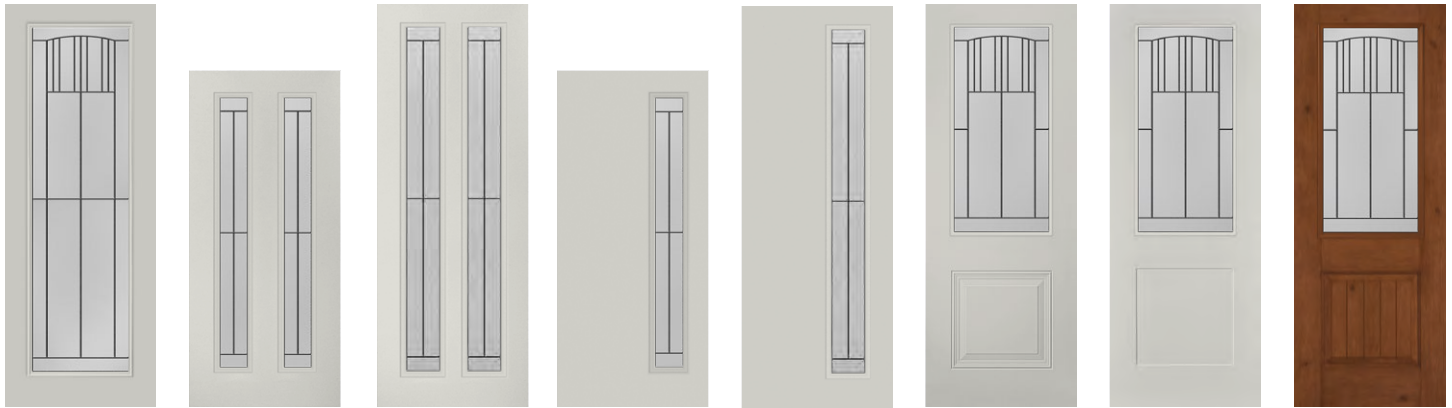

686
8/0 height

694

694
8/0 height

694-1
left or right

694-1
8/0 height
left or right

984
8/0 height

984F
8/0 height

984P
8/0 height





MONTEREY

Monterey offers Craftsman design elements and a bit of modern style to your home's entrance door. Clear bevels provide visibility while the translucent, textured glass offers a medium-high privacy level. Patina and satin nickel give you finish options to complement your door hardware.

Patina and Satin Nickel caming ● Glass Code: MNT



craftsman design elements & a bit of modern style



	CAMBRIDGE SMOOTH	WESTGUARD SMOOTH	NORWOOD TEXTURED	TRUGRAIN™	TIMBERLINE SMOOTH	TIMBERLINE TEXTURED FIR	TIMBERGRAIN CHERRY	TIMBERGRAIN FIR	TIMBERGRAIN KNOTTY ALDER	TIMBERGRAIN MAHOGANY	TIMBERGRAIN OAK
	STEEL DOORS					FIBERGLASS DOORS					
502S	●●	●									
606	●●				●●		●●●				●●
606P							●●●				
607	●●		●●●		●		●●			●●	●●
684	●●●	●●	●●●	●●●	●●		●●			●●	●●
686	●●	●	●●	●●	●●	●	●●	●●	●●	●●	●●
694	●●	●	●●	●●	●						
694-1	●●	●	●●	●●	●●						
865					●	●					
866	●●										
866F	●●	●	●	●●							
866P	●										
984	●●●	●●	●●●		●●				●●●		
984F	●●●	●●	●	●●	●	●					
984P	●		●						●●●		
	STEEL SIDELITES					FIBERGLASS SIDELITES					
422	●				●		●●●			●●	●●
690							●●	●●	●●	●●	●●
692							●		●		
694	●●		●●	●●	●●						

Availability based on 3/0 width for doors and 14" for sidelites. ● 6/8 height ● 7/0 height ● 8/0 height
Other panel configurations and sizes may be available.



Featured with ZEEL glass frame
see page 40 for details





HEARTLAND

When you think Craftsman style, you're thinking Heartland. A patina finish and handcrafted, textured glass create a striking geometric pattern reminiscent of Arts and Crafts design. Four glass types create a bright entryway and medium privacy level.

Patina coming ● Glass Code: HRT

Privacy Rating:  5
TRANSPARENT OPAQUE

Add a geometric pattern to your home's entryway



	CAMBRIDGE SMOOTH	WESTGUARD SMOOTH	NORWOOD TEXTURED	TRUGRAIN™	TIMBERLINE SMOOTH	TIMBERLINE TEXTURED FIR	TIMBERGRAIN CHERRY	TIMBERGRAIN FIR	TIMBERGRAIN KNOTTY ALDER	TIMBERGRAIN MAHOGANY	TIMBERGRAIN OAK
	STEEL DOORS					FIBERGLASS DOORS					
606	●●				●●		●●●				●●
606P							●●●				
607	●●		●●●		●		●●			●●	●●
684	●●●	●●	●●●	●●●	●●		●●			●●	●●
686	●●●	●●	●●●	●●●	●●●	●	●●	●●●	●●	●●	●●
692	●●	●	●●	●●	●						
694	●●●	●●	●●●	●●	●●						
694-1	●●●	●●	●●	●●	●●						
864								●●			
865					●	●					
866	●●										
866F	●●	●	●	●●							
866P	●										
984	●●●	●●	●●●		●●				●●●		
984F	●●●	●●	●	●●	●	●					
984P	●		●						●●●		
	STEEL SIDELITES					FIBERGLASS SIDELITES					
422	●		●		●		●●●			●●	●●
690							●●	●●	●●	●●	●●
692	●		●	●●	●		●●●		●●●	●●	●●
694	●●●		●●●	●●●	●●●						

Availability based on 3/0 width for doors and 14" for sidelites.
 ● 6/8 height ● 7/0 height ● 8/0 height
 Other panel configurations and sizes may be available.





606



606
8/0 height



606P



606P
8/0 height

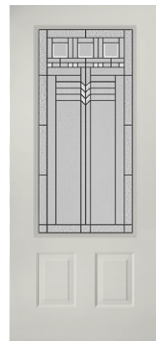

607



607
8/0 height



684



684
8/0 height

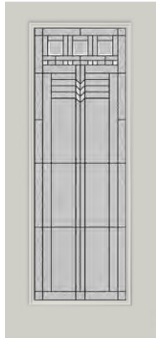

686

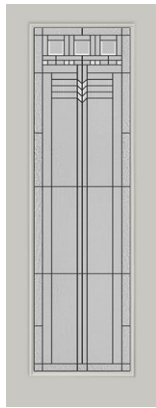

686
8/0 height

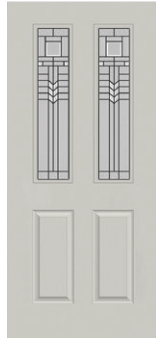

692

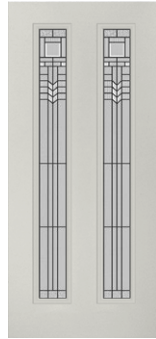

694

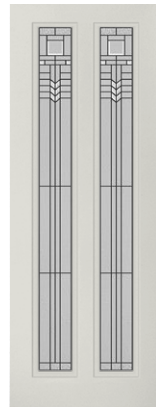

694
8/0 height

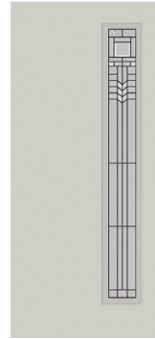

694-1
left or right

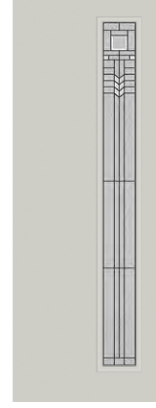

694-1
8/0 height
left or right

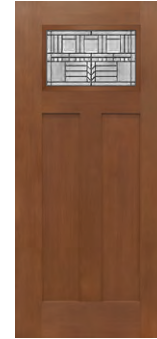

864
Option: dentil shelf



865

Option: dentil shelf



866

Option: dentil shelf



866F

Option: dentil shelf
(Cambridge & Norwood)



866P

Option: dentil shelf



984

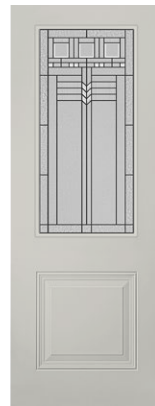

984
8/0 height



984F



984F
8/0 height



984P



984P
8/0 height



422

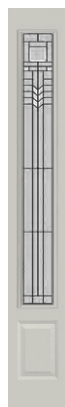

422
8/0

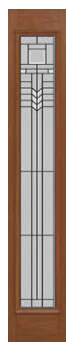

690



692

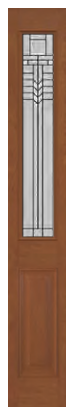

692
8/0



694

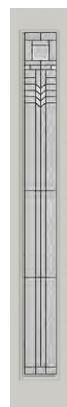

694
8/0



TR90
(14-3/0-14 ONLY)



URBAN

Collection

Hip and trending, our urban style exterior doorglass designs stand all on their own. Each style features simple, clean lines and can naturally provide your home with a sophisticated yet comfortable feel.



BROWNSTONE



BARCELLO

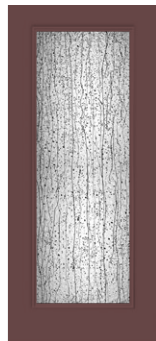

MISTIFY

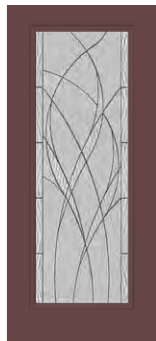

WATERSIDE

design ———
YOUR HOME

- + exposed pipes
- + metal pendant light fixtures
- + leather furniture in warm tones
- + neutral color palettes
- + slate, red brick & concrete



BROWNSTONE

Stylish Brownstone can be elegantly integrated into the architectural styles of another era or matched with the simple, sleek lines of today. Beveling is the hallmark of this refined design. Brownstone offers a medium level of privacy.

Patina coming ● Glass Code: BRO

Privacy Rating: 6
TRANSPARENT OPAQUE

	CAMBRIDGE SMOOTH	WESTGUARD SMOOTH	NORWOOD TEXTURED	TRUGRAIN™	TIMBERLINE SMOOTH	TIMBERLINE TEXTURED FIR	TIMBERGRAIN CHERRY	TIMBERGRAIN FIR	TIMBERGRAIN KNOTTY ALDER	TIMBERGRAIN MAHOGANY	TIMBERGRAIN OAK
	STEEL DOORS						FIBERGLASS DOORS				
502S	●●	●									
606	●●				●●		●●●				●●
606P							●●●				
607	●●		●●●		●		●●			●●	●●
684	●●●	●●	●●●	●●●	●●		●●			●●	●●
686	●●	●	●●	●●	●●	●	●●	●●	●●	●●	●●
692	●●	●	●●	●●	●						
984	●●●	●●	●●●		●●				●●●		
984F	●●●	●●	●	●●	●	●					
984P	●		●						●●●		
	STEEL SIDELITES						FIBERGLASS SIDELITES				
422							●●			●●	●●
692	●		●	●●	●		●●●		●●●	●●	●●

Availability based on 3/0 width for doors and 14" for sidelites. ● 6/8 height ● 7/0 height ● 8/0 height
Other panel configurations and sizes may be available.

*create stunning light effects
in your home's foyer*



design tip

Pair with Chinchilla glass sidelites for a timeless touch





BARCELLO

Barcello's industrial and contemporary style is one of a kind. Mixing bold textures and the sleek industrial look of its perforated aluminum bar, Barcello is the perfect doorglass for an entrance where a contrast of patterns and styles is desired.

Zinc caming ● Glass Code: BRL

Privacy Rating:  6
TRANSPARENT OPAQUE

	CAMBRIDGE SMOOTH	WESTGUARD SMOOTH	NORWOOD TEXTURED	TRUGRAIN™	TIMBERLINE SMOOTH	TIMBERLINE TEXTURED FIR	TIMBERGRAIN CHERRY	TIMBERGRAIN FIR	TIMBERGRAIN KNOTTY ALDER	TIMBERGRAIN MAHOGANY	TIMBERGRAIN OAK
	STEEL DOORS					FIBERGLASS DOORS					
606	●●				●●		●●●				●●
606P							●●●				●●
607	●●		●●●		●		●●			●●	●●
684	●	●	●	●	●						
686	●●	●	●●	●●	●●	●	●●	●●	●●	●●	●●
694-1	●●	●	●●	●●	●●						
984	●	●	●		●				●		
984F	●	●									
984P									●		
	STEEL SIDELITES					FIBERGLASS SIDELITES					
422	●		●		●		●●			●●	●●
692							●		●		
694	●●		●●	●●	●●						

Availability based on 3/0 width for doors and 14" for sidelites. ● 6/8 height ● 7/0 height ● 8/0 height
Other panel configurations and sizes may be available.

*add an industrial look
to your entryway*



design tip

Create an individualized style by mixing textures and materials, including metal, brick and wood.



606

606
8/0 height

606P

606P
8/0 height

607

607
8/0 height

684
8/0 height



686

694-1
left or right

984
8/0 height

984F
8/0 height

984P
8/0 height

422

422
8/0

692
8/0

694

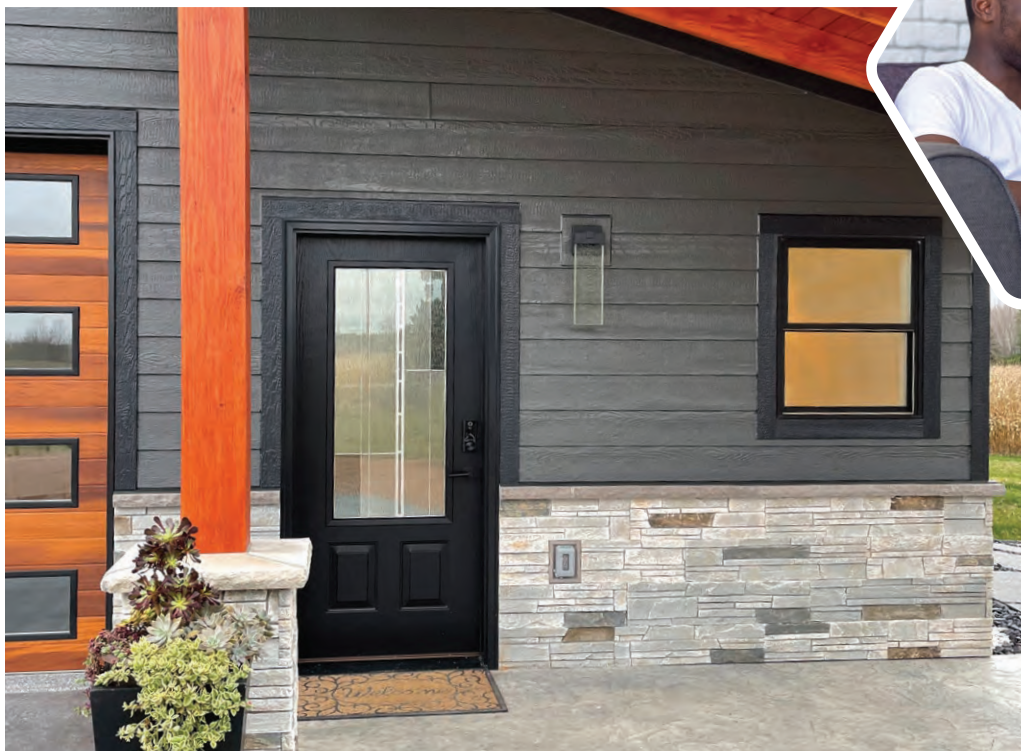



MISTIFY

Mistify is the playful combination of pattern and texture. The black drizzle pattern is fused to softly textured glass, resulting in a mesmerizing statement piece for any modern entryway and privacy for the home.

Glass Code: MYB

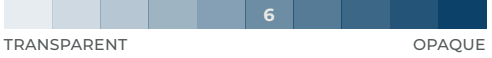
Privacy Rating:  6
TRANSPARENT OPAQUE

*the perfect pattern to
make a design statement*



	CAMBRIDGE SMOOTH	WESTGUARD SMOOTH	NORWOOD TEXTURED	TRUCRAIN™	TIMBERLINE SMOOTH	TIMBERLINE TEXTURED FIR	TIMBERGRAIN CHERRY	TIMBERGRAIN FIR	TIMBERGRAIN KNOTTY ALDER	TIMBERGRAIN MAHOGANY	TIMBERGRAIN OAK
	STEEL DOORS					FIBERGLASS DOORS					
461C	●●	●	●●		●						
502S	●●	●									
606	●●				●●		●●●				●●
606P							●●●				
607	●●		●●●		●		●●			●●	●●
684	●●●	●●	●●●	●●●	●●		●●			●●	●●
686	●●●	●●	●●●	●●●	●●●	●	●●	●●●	●●	●●	●●
692	●●	●	●●	●●	●						
694	●●●	●●	●●●	●●	●●						
694-1	●●●	●●	●●	●●	●●						
865					●	●					
866	●●										
866F	●●	●	●	●●							
866P	●										
984	●●●	●●	●●●		●●				●●●		
984F	●●●	●●	●	●●	●	●					
984P	●		●						●●●		
	STEEL SIDELITES					FIBERGLASS SIDELITES					
422	●				●		●●●			●●	●●
690							●●	●●	●●	●●	●●
692	●		●	●●	●		●●●		●●●	●●	●●
694	●●●		●●●	●●●	●●●						

Availability based on 3/0 width for doors and 14" for sidelites.
 ● 6/8 height ● 7/0 height ● 8/0 height
 Other panel configurations and sizes may be available.





461C

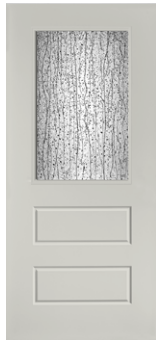

502S



606



606
8/0 height



606P



606P
8/0 height



607



607
8/0 height



684

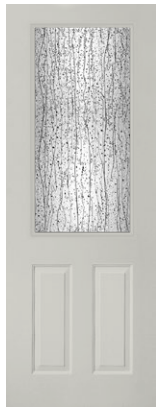

684
8/0 height



686



686
8/0 height



692



694



694
8/0 height



694-1
left or right



694-1
8/0 height
left or right



865
Option: dentil shelf



866
Option: dentil shelf



866F
Option: dentil shelf
(Cambridge & Norwood)



866P
Option: dentil shelf



984

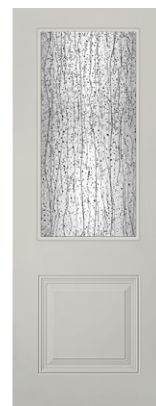

984
8/0 height



984F

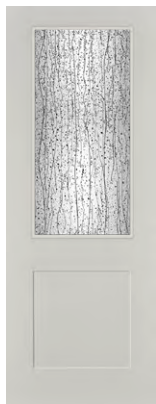

984F
8/0 height



984P



984P
8/0 height



422



422
8/0



690



692
8/0



692
8/0



694

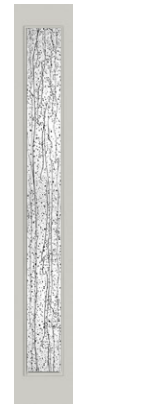

694
8/0



WATERSIDE

Natural, free-flowing movement extends the length of Waterside and brings to mind a flowing river or grasses swaying in the breeze. The black chrome coming pairs well with metal house numbers and black entryway sconces. Waterside offers a high privacy level.

Black Chrome coming ● Glass Code: WTS

Privacy Rating: 8
TRANSPARENT OPAQUE

*bring the feeling of
a flowing river to your home*



	CAMBRIDGE SMOOTH	WESTGUARD SMOOTH	NORWOOD TEXTURED	TRUGRAIN™	TIMBERLINE SMOOTH	TIMBERLINE TEXTURED FIR	TIMBERGRAIN CHERRY	TIMBERGRAIN FIR	TIMBERGRAIN KNOTTY ALDER	TIMBERGRAIN MAHOGANY	TIMBERGRAIN OAK
	STEEL DOORS					FIBERGLASS DOORS					
502S	●●	●									
606	●●				●		●●●				●●
606P							●●●				
607	●●		●●●		●		●●			●●	●●
684	●●●	●●	●●●	●●●	●●		●●			●●	●●
686	●●●	●●	●●●	●●●	●●●	●	●●	●●●	●●	●●	●●
692	●●	●	●●	●	●						
694	●●	●	●●	●	●						
694-1	●●●	●●	●●	●●	●●						
984	●●●	●●	●●●		●●				●●●		
984F	●●●	●●	●	●●	●	●					
984P	●		●						●●●		
	STEEL SIDELITES					FIBERGLASS SIDELITES					
422	●				●		●●●			●●	●●
690							●●		●●	●●	●●
692	●		●●	●●	●		●●●		●●●	●●	●●
694	●●●		●●●	●●●	●●●						

Availability based on 3/0 width for doors and 14" for sidelites. ● 6/8 height ● 7/0 height ● 8/0 height
Other panel configurations and sizes may be available.





606

606
8/0 height

606P

606P
8/0 height

607

607
8/0 height

684

684
8/0 height

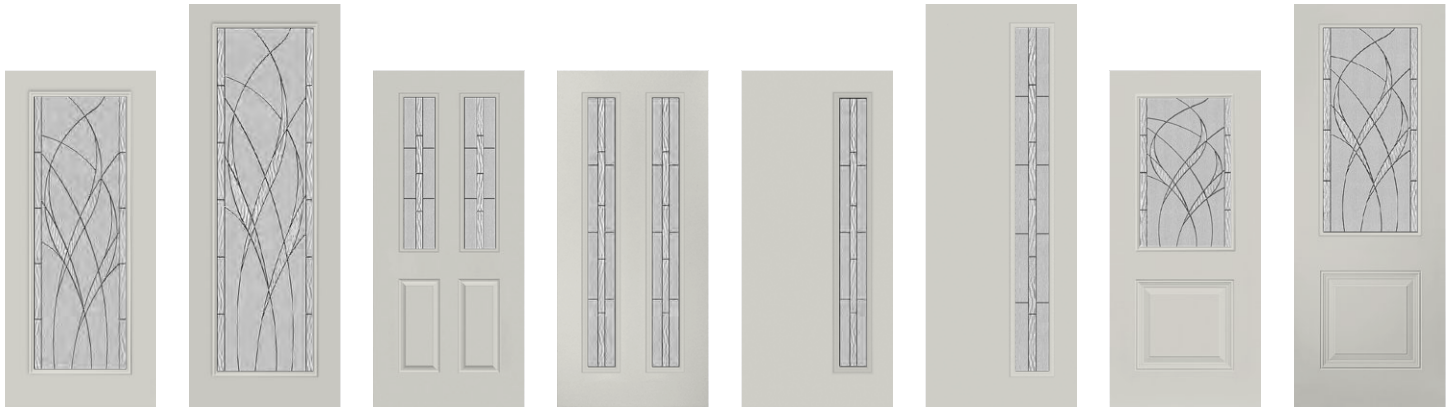

686

686
8/0 height

692

694

694-1
left or right

694-1
8/0 height
left or right

984

984
8/0 height



984F

984F
8/0 height

984P

984P
8/0 height

422

422
8/0

690

692
8/0

692

694

694
8/0





MODERN
Collection

Less is more when it comes to modern style. Clean lines, uncluttered spaces and open layouts are elements of this popular design style.

With our Modern glass collection you can achieve a bold look through simplicity and minimalism.

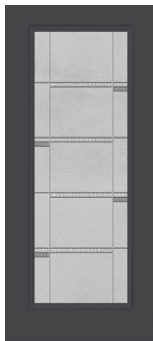

CROSSWALK



GLACIER



PRIVACY GLASS
Details shown in
Privacy collection
on pg. 68-69

design ———
└───┬───┐
YOUR HOME

- + crisp, geometric lines
- + neutral color scheme with pops of color for doors and accent pieces
- + floor-to-ceiling windows
- + use of natural materials, such as concrete, wood, and steel



GLACIER

This multi-levelled textured glass was inspired by brick and stone finishes to deliver a bolder, edgier look to your entrance way. Glacier is a strong and modern imprint that will look great in the most natural of decors.

Glass Code: GLA

Privacy Rating:  7
TRANSPARENT OPAQUE

*captures the essence
of a natural décor*

	CAMBRIDGE SMOOTH	WESTGUARD SMOOTH	NORWOOD TEXTURED	TRUGRAIN™	TIMBERLINE SMOOTH	TIMBERLINE TEXTURED FIR	TIMBERGRAIN CHERRY	TIMBERGRAIN FIR	TIMBERGRAIN KNOTTY ALDER	TIMBERGRAIN MAHOGANY	TIMBERGRAIN OAK
	STEEL DOORS					FIBERGLASS DOORS					
502S	●●	●									
606	●●				●●		●●●				●●
606P							●●●				
607	●●		●●●		●		●●			●●	●●
684	●●●	●●	●●●	●●●	●●		●●			●●	●●
686	●●	●	●●	●●	●●	●	●●	●●	●●	●●	●●
692	●●	●	●●	●●	●						
694-1	●●	●	●●	●●	●●						
984	●●●	●●	●●●		●●				●●●		
984F	●●●	●●	●	●●	●	●					
984P	●		●						●●●		
	STEEL SIDELITES					FIBERGLASS SIDELITES					
422	●				●		●●			●●	●●
692	●		●	●●	●		●●●		●●●	●●	●●
694	●●		●●	●●	●●						

Availability based on 3/0 width for doors and 14" for sidelites. ● 6/8 height ● 7/0 height ● 8/0 height
 Other panel configurations and sizes may be available.



design tip

Pair with a Clear glass transom for added light in your foyer





CROSSWALK

Modern design comes to life through strong linear lines interrupted by bold pops of gray glass. Crosswalk's look is abstract, modern, and stylish, and it offers a high privacy level.

Nickel caming ● Glass Code: CWK

Privacy Rating:  8
TRANSPARENT OPAQUE

*a unique minimalist design
for your entryway*

	CAMBRIDGE SMOOTH	WESTGUARD SMOOTH	NORWOOD TEXTURED	TRUGRAIN™	TIMBERLINE SMOOTH	TIMBERLINE TEXTURED FIR	TIMBERGRAIN CHERRY	TIMBERGRAIN FIR	TIMBERGRAIN KNOTTY ALDER	TIMBERGRAIN MAHOGANY	TIMBERGRAIN OAK
	STEEL DOORS					FIBERGLASS DOORS					
606	●●				●		●●●				●●
606P							●●●				
607	●●		●●●		●		●●			●●	●●
684	●●●	●●	●●●	●●●	●●		●●			●●	●●
686	●●●	●●	●●●	●●●	●●●	●	●●	●●●	●●	●●	●●
692	●●	●	●●	●	●						
694	●●	●	●●	●	●						
694-1	●●●	●●	●●	●●	●●						
865					●	●					
866	●●										
866F	●●	●	●	●●							
866P	●										
984	●●●	●●	●●●		●●				●●●		
984F	●●●	●●	●	●●	●	●					
984P	●		●						●●●		
	STEEL SIDELITES					FIBERGLASS SIDELITES					
422	●				●		●●●			●●	●●
690							●●		●●	●●	●●
692	●		●●	●●	●		●●●		●●●	●●	●●
694	●●●		●●●	●●●	●●●						

Availability based on 3/0 width for doors and 14" for sidelites. ● 6/8 height ● 7/0 height ● 8/0 height
Other panel configurations and sizes may be available.





606

606
8/0 height

606P

606P
8/0 height

607

607
8/0 height

684

684
8/0 height



686

686
8/0 height

692

694

694-1
left or right

694-1
8/0 height
left or right

865
Option: dentil shelf

866
Option: dentil shelf



866F

Option: dentil shelf
(Cambridge & Norwood)

866P

Option: dentil shelf

984

984
8/0 height

984F

984F
8/0 height

984P

984P
8/0 height



422

422
8/0

690

692

692
8/0

694

694
8/0





RUSTIC

Collection

Our Rustic glass collection provides a handcrafted aesthetic that will infuse your home with familiar comfort and warmth. Your guests will instantly feel at home.

These doors aren't just for your cabin in the woods; rustic style glass can add the perfect natural element to any design style. Bring the beauty of the great outdoors into your entry way with our Rustic Collection.

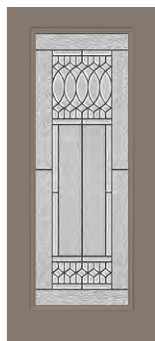

MARTIEL

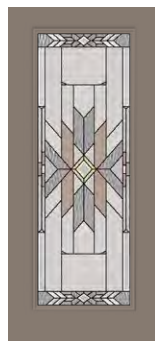

MOHAVE

design YOUR HOME

- + focus on wood and stone elements
- + bold, simple patterns
- + welcoming stone fireplace
- + linen, wool, burlap, and canvas fabrics
- + mix and match wood species



MARTIEL

Your design sophistication and love of all things European make Martiel the fitting choice for your home. An elegant arrangement of clear beveled glass, textured glass, and patina finish define the styling of our Rustic Collection.

Patina coming ◆ Glass Code: MAR

Privacy Rating:
4
TRANSPARENT
OPAQUE

*welcome friends & family
with a rustic inviting entry*



	CAMBRIDGE SMOOTH	WESTGUARD SMOOTH	NORWOOD TEXTURED	TRUGRAIN™	TIMBERLINE SMOOTH	TIMBERLINE TEXTURED FIR	TIMBERGRAIN CHERRY	TIMBERGRAIN FIR	TIMBERGRAIN KNOTTY ALDER	TIMBERGRAIN MAHOGANY	TIMBERGRAIN OAK
	STEEL DOORS					FIBERGLASS DOORS					
502S	●●	●									
601							●●				
601P							●●				
606	●●				●●		●●●				●●
606P							●●●				
607	●●		●●●		●		●●			●●	●●
684	●●●	●●	●●●	●●	●●		●●			●●	●●
686	●●●	●●	●●●	●●●	●●●	●	●●	●●●	●●	●●	●●
692	●●	●	●●	●●	●						
694	●●●	●●	●●●	●●	●●						
694-1	●●●	●●	●●	●●	●●						
864								●●			
973									●		
973P									●		
984	●●●	●●	●●●		●●				●●●		
984F	●●●	●●	●	●●	●	●					
984P	●		●						●●●		
	STEEL SIDELITES					FIBERGLASS SIDELITES					
422	●				●		●●●			●●	●●
690							●●	●●	●●	●●	●●
692	●		●	●●	●		●●●		●●●	●●	●●
694	●●●		●●●	●●●	●●●						

Availability based on 3/0 width for doors and 14" for sidelites.
 ● 6/8 height ● 7/0 height ● 8/0 height
 Other panel configurations and sizes may be available.



502S



601



601P



606



606
8/0 height



606P



606P
8/0 height



607

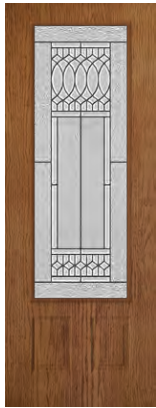

607
8/0 height



684



684
8/0 height

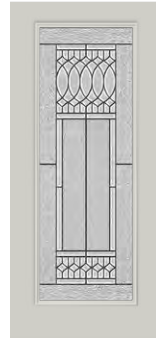

686

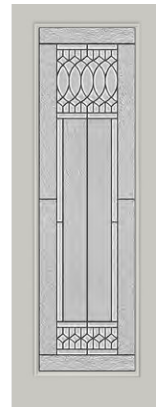

686
8/0 height



692

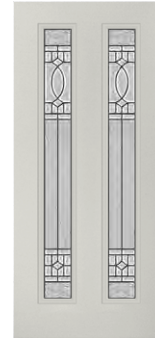

694

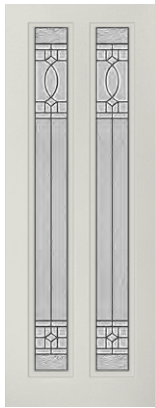

694
8/0 height

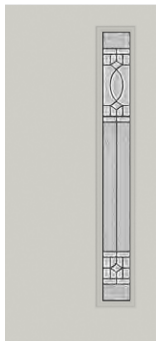

694-1
left or right

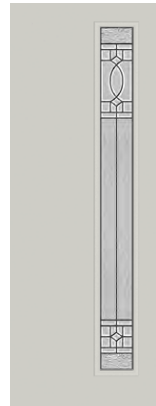

694-1
8/0 height
left or right



864
Option: dentil shelf



973
8/0 height



973P
8/0 height



984



984
8/0 height



984F

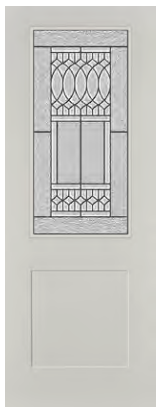

984F
8/0 height



984P



984P
8/0 height



422

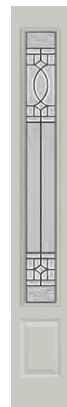

422
8/0



690



692



692
8/0



694



694
8/0



TR90
(14-3/0-14 ONLY)



MOHAVE

Shades of the desert accent your home's entrance door. A blend of amber, bronze, and gray shades with a mix of translucent, clear, and textured glass make a truly rustic statement. Mohave features an oil-rubbed bronze finish and high privacy level.

Oil-Rubbed Bronze caming ● Glass Code: MOH

Privacy Rating:  7
TRANSPARENT OPAQUE

*the soft colored glass
creates a warm welcome*



	CAMBRIDGE SMOOTH	WESTGUARD SMOOTH	NORWOOD TEXTURED	TRUGRAIN™	TIMBERLINE SMOOTH	TIMBERLINE TEXTURED FIR	TIMBERGRAIN CHERRY	TIMBERGRAIN FIR	TIMBERGRAIN KNOTTY ALDER	TIMBERGRAIN MAHOGANY	TIMBERGRAIN OAK
	STEEL DOORS					FIBERGLASS DOORS					
502S	●●	●									
606	●●				●●		●●●				●●
606P							●●●				
607	●●		●●●		●		●●			●●	●●
684	●●●	●●	●●●	●●●	●●		●●			●●	●●
686	●●●	●●	●●●	●●●	●●●	●	●●	●●●	●●	●●	●●
692	●●	●	●●	●●	●						
694	●●●	●●	●●●	●●	●●						
694-1	●●●	●●	●●	●●	●●						
984	●●●	●●	●●●		●●				●●●		
984F	●●●	●●	●	●●	●	●					
984P	●		●						●●●		
	STEEL SIDELITES					FIBERGLASS SIDELITES					
422	●				●		●●●			●●	●●
690							●●	●●	●●	●●	●●
692	●		●	●●	●		●●●		●●●	●●	●●
694	●●●		●●●	●●●	●●●						

Availability based on 3/0 width for doors and 14" for sidelites. ● 6/8 height ● 7/0 height ● 8/0 height
Other panel configurations and sizes may be available.





TRADITIONAL

Collection

These timeless designs are rooted in the great traditions of American architecture. Beautiful lines, sophisticated detailing, and deeply cut bevels create an understated ambiance that adds beauty and value to your home. Choose from a rich variety of doorglass styles that will provide enduring beauty and lasting value for your home.

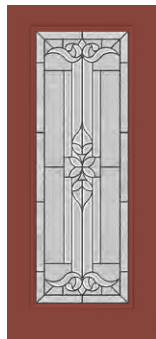

CANTEBERRY



HARRISON

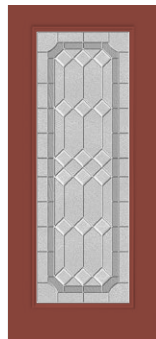

OXFORD



REGENCY

design ———
└───┬───┐
YOUR HOME

- + patterned rugs & framed art
- + tufted upholstery in chairs, sofas and headboards
- + soft neutral color palettes paired with rich woods
- + symmetry in designs



CANTEBERRY

Canteberry flows into floral-inspired bevel clusters, defined with a patina coming finish. This doorglass creates a bright and classic entrance to your home. Canteberry offers a medium level of privacy.

Patina coming  Glass Code: CNT

Privacy Rating:  5
 TRANSPARENT OPAQUE

*create a bright entrance
to your home*



	CAMBRIDGE SMOOTH	WESTGUARD SMOOTH	NORWOOD TEXTURED	TRUGRAIN™	TIMBERLINE SMOOTH	TIMBERLINE TEXTURED FIR	TIMBERGRAIN CHERRY	TIMBERGRAIN FIR	TIMBERGRAIN KNOTTY ALDER	TIMBERGRAIN MAHOGANY	TIMBERGRAIN OAK
	STEEL DOORS						FIBERGLASS DOORS				
601							●●				
601P							●●				
606	●●				●●		●●●				●●
606P							●●●				
607	●●		●●●		●		●●			●●	●●
608							●●			●●	●●
648							●●			●●	●●
684	●	●	●	●	●						
686	●●●	●●	●●●	●●●	●●●	●	●●	●●●	●●	●●	●●
694	●●	●	●●●	●●	●●						
694-1	●●●	●●	●●	●●	●●						
864								●●			
937							●●				
937A							●●				
937C							●●			●●	●●
973									●		
973P									●		
984	●	●	●	●	●				●		
984F	●	●									
984P									●		
	STEEL SIDELITES					FIBERGLASS SIDELITES					
422	●		●		●		●●●			●●	●●
690							●●	●●	●●	●●	●●
692							●		●		
694	●●●		●●●	●●●	●●●						

Availability based on 3/0 width for doors and 14" for sidelites. ● 6/8 height ● 7/0 height ● 8/0 height
 Other panel configurations and sizes may be available.



601



601P



606



606
8/0 height



606P



606P
8/0 height



607



607
8/0 height



608



648



684
8/0 height

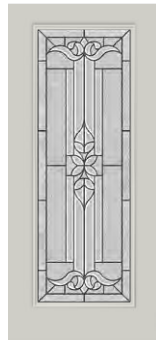

686



686
8/0 height

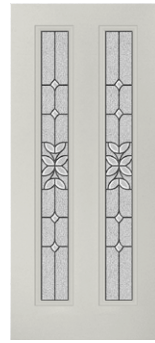

694

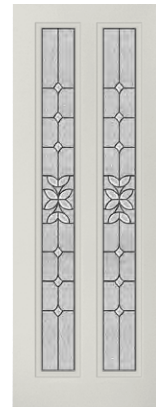

694
8/0 height

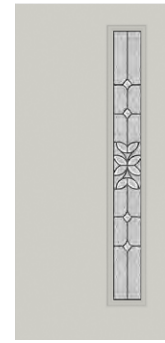

694-1
left or right

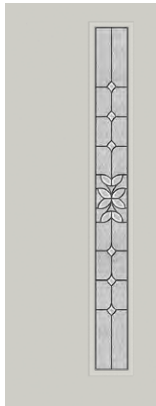

694-1
8/0 height
left or right

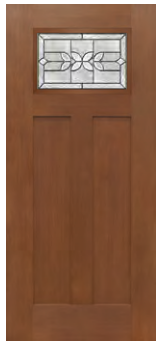

864
Option: dentil shelf



937



937A



937C



973
8/0 height



973P
8/0 height



984
8/0 height



984F
8/0 height



984P
8/0 height



422

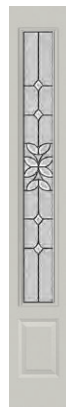

422
8/0



690



692
8/0



694



694
8/0



HARRISON

Harrison places a brilliant bevel cluster at its center and frames it with a translucent beveled glass design. Complement your home's décor with a choice of patina or nickel finish. Harrison offers a medium privacy level.

Nickel or Patina coming Glass Code: HRR

Privacy Rating: 6
TRANSPARENT OPAQUE

Classic translucent beveled glass design

	CAMBRIDGE SMOOTH	WESTGUARD SMOOTH	NORWOOD TEXTURED	TRUGRAIN™	TIMBERLINE SMOOTH	TIMBERLINE TEXTURED FIR	TIMBERGRAIN CHERRY	TIMBERGRAIN FIR	TIMBERGRAIN KNOTTY ALDER	TIMBERGRAIN MAHOGANY	TIMBERGRAIN OAK
	STEEL DOORS					FIBERGLASS DOORS					
502S	●●	●									
606	●●				●●		●●●				●●
606P							●●●				
607	●●		●●●		●		●●			●●	●●
659	●●		●●		●						
684	●●●	●●	●●●	●●●	●●		●●			●●	●●
686	●●	●	●●	●●	●●	●	●●	●●	●●	●●	●●
692	●●	●	●●	●●	●						
694	●●	●	●●	●●	●						
694-1	●●	●	●●	●●	●●						
919	●●	●	●●		●						
984	●●●	●●	●●●		●●				●●●		
984F	●●●	●●	●	●●	●	●					
984P	●		●						●●●		
	STEEL SIDELITES					FIBERGLASS SIDELITES					
422	●				●		●●●			●●	●●
690							●●	●●	●●	●●	●●
692	●		●	●●	●		●●●		●●●	●●	●●
694	●●		●●	●●	●●						

Availability based on 3/0 width for doors and 14" for sidelites. ● 6/8 height ● 7/0 height ● 8/0 height
Other panel configurations and sizes may be available.





502S

606

606
8/0 height

606P

606P
8/0 height

607

607
8/0 height

659



684

684
8/0 height

686

692

694

694-1
left or right

919

984



984
8/0 height

984F

984F
8/0 height

984P

984P
8/0 height

422

422
8/0

690

692

692
8/0

694



TR90
(14-3/0-14 ONLY)





OXFORD

Oxford's formal pattern of beveled glass, accented with gray shades, is the epitome of traditional design. The nickel coming complements door hardware, light fixtures, and interior furnishings. Oxford provides a medium level of privacy.

Nickel coming ● Glass Code: OXF

Privacy Rating:  6
TRANSPARENT OPAQUE

*Epitome of
Traditional Design*

	CAMBRIDGE SMOOTH	WESTGUARD SMOOTH	NORWOOD TEXTURED	TRUGRAIN™	TIMBERLINE SMOOTH	TIMBERLINE TEXTURED FIR	TIMBERGRAIN CHERRY	TIMBERGRAIN FIR	TIMBERGRAIN KNOTTY ALDER	TIMBERGRAIN MAHOGANY	TIMBERGRAIN OAK
	STEEL DOORS					FIBERGLASS DOORS					
502S	●●	●									
606	●●				●●		●●●				●●
606P							●●●				
607	●●		●●●		●		●●			●●	●●
684	●●●	●●	●●●	●●●	●●		●●			●●	●●
686	●●●	●●	●●●	●●●	●●●	●	●●	●●●	●●	●●	●●
692	●●	●	●●	●●	●						
694	●●●	●●	●●●	●●	●●						
694-1	●●●	●●	●●	●●	●●						
984	●●●	●●	●●●		●●				●●●		
984F	●●●	●●	●	●●	●	●					
984P	●		●						●●●		
	STEEL SIDELITES					FIBERGLASS SIDELITES					
422	●				●		●●●			●●	●●
690							●●	●●	●●	●●	●●
692	●		●	●●	●		●●●		●●●	●●	●●
694	●●●		●●●	●●●	●●●						

Availability based on 3/0 width for doors and 14" for sidelites. ● 6/8 height ● 7/0 height ● 8/0 height
Other panel configurations and sizes may be available.





502S

606

606
8/0 height

606P

606P
8/0 height

607

607
8/0 height

684

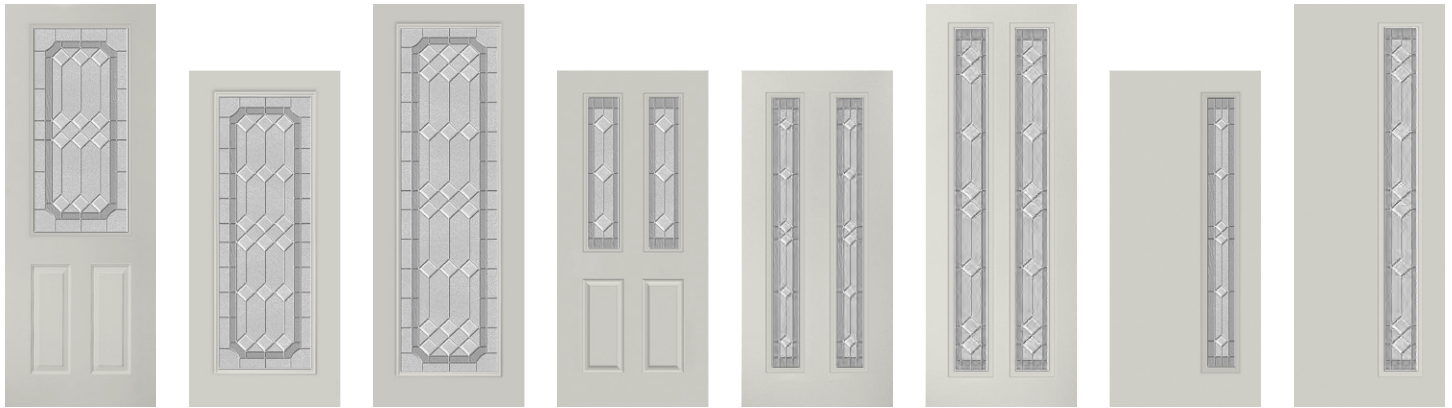

684
8/0 height

686

686
8/0 height

692

694

694
8/0 height

694-1
left or right

694-1
8/0 height
left or right



984

984
8/0 height

984F

984F
8/0 height

984P

984P
8/0 height



422

422
8/0

690

692

692
8/0

694

694
8/0





REGENCY

The value you place on history makes Regency your perfect choice. Its deeply cut beveled glass and satin nickel or brass finish create a classic design that endures, just like the family treasures that lie within your home.

Brass or Satin Nickel caming ● Glass Code: REG

Privacy Rating: 6
TRANSPARENT OPAQUE

*A design that endures
the test of time*



	CAMBRIDGE SMOOTH	WESTGUARD SMOOTH	NORWOOD TEXTURED	TRUGRAIN™	TIMBERLINE SMOOTH	TIMBERLINE TEXTURED FIR	TIMBERGRAIN CHERRY	TIMBERGRAIN FIR	TIMBERGRAIN KNOTTY ALDER	TIMBERGRAIN MAHOGANY	TIMBERGRAIN OAK
	STEEL DOORS					FIBERGLASS DOORS					
502S	●●	●									
601							●●				
601P							●●				
606	●●				●●		●●●				●●
606P							●●●				
607	●●		●●●		●		●●			●●	●●
659	●●		●●		●						
684	●●●	●●	●●●	●●●	●●		●●			●●	●●
686	●●●	●●	●●●	●●●	●●●	●	●●	●●●	●●	●●	●●
692	●●	●	●●	●●	●						
694	●●●	●●	●●●	●●	●●						
694-1	●●●	●●	●●	●●	●●						
864								●●			
919	●●	●	●●		●						
937							●●				
937A							●●				
937C							●●			●●	●●
973									●		
973P									●		
984	●●●	●●	●●●		●●				●●●		
984F	●●●	●●	●	●●	●	●					
984P	●		●						●●●		
	STEEL SIDELITES					FIBERGLASS SIDELITES					
422	●				●		●●●			●●	●●
690							●●	●●	●●	●●	●●
692	●		●	●●	●		●●●		●●●	●●	●●
694	●●●		●●●	●●●	●●●						

Availability based on 3/0 width for doors and 14" for sidelites. ● 6/8 height ● 7/0 height ● 8/0 height
Other panel configurations and sizes may be available.

NOTE: The 686, 694, and 694-1 styles are only available with Satin Nickel caming in the 8/0 height.



TR90
(14-3/0-14 ONLY)



134 422 422 8/0 690 692 692 8/0 694 694 8/0 Satin Nickel caming



502S



601



601P



606



606
8/0 height



606P



606P
8/0 height



607



607
8/0 height



659



684



684
8/0 height



686



686
8/0 height
Satin Nickel caming



692



694



694
8/0 height
Satin Nickel caming

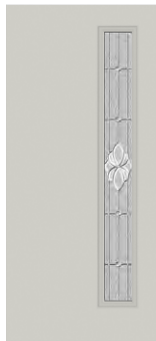

694-1
left or right

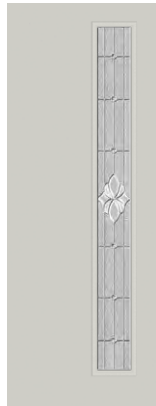

694-1
8/0 height
Satin Nickel caming
left or right

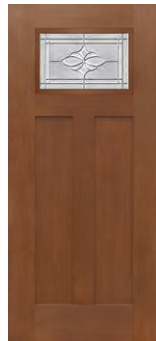

864
Option: dentil shelf



919



937



937A



937C



973
8/0 height



973P
8/0 height



984



984
8/0 height



984F



984F
8/0 height



984P



984P
8/0 height 135

INNOVATIONS DIGITAL DESIGNS

Elevate your space with digitally printed woodgrain doors, available in 1- or 2-panel flat shaker styles, with five patterns choices: Light Barnwood, Dark Barnwood, Black, White, and Grey. These innovative doors are ideal for house-to-garage, man caves, dens, she sheds, and more!



2-PANEL FLAT SHAKER



DP21



DP22



DP23



DP24



DP25

1-PANEL FLAT SHAKER



DP31



DP32

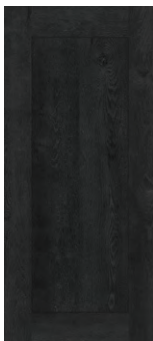

DP33



DP34



DP35

DOOR PANEL DETAILS

- 22-gauge Cambridge Smooth Steel door
- Full steel-edge perimeter offers additional strength and the industry's highest security rating
- Resists denting, cracking, splitting, warping and twisting
- Adjustable Hinge Plate System
- Polyurethane foam core fills every void to protect from heat loss or gain
- Composite lock block provides secure mounting for door hardware. Won't absorb moisture or swell like wood lock blocks.
- Fire rated up to 90 minutes
- Limited lifetime warranty



4-FOOT WIDE DOORS

Wide openings allow motorcycles, lawn mowers, small equipment, and other large items to pass through without requiring an overhead or double door. The 4/0 wide door features a WestGuard 20-gauge Smooth Steel panel with the Adjustable Hinge Plate System.

Available with Clear or Low-E glass

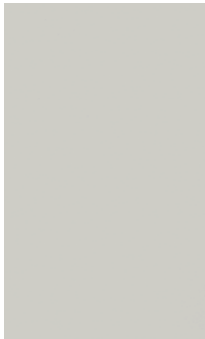

1
● ● ●



2 (shown in Rain)
● ● ●



2V
● ●



2-9L
● ● ●



2-9LP
● ● ●



866-FL
● ● ●

Availability based on 4/0 width. ● 6/8 height ● 7/0 height ● 8/0 height Other panel configurations and sizes may be available. 🔥 Can be labeled for fire rating.



◀◀ 4 FOOT WIDE ▶▶

open wider

- agricultural buildings
- yard barns
- garage service entrances
- ADA applications

Choose Your Frame Type

Protect your home with durable, low maintenance door frames that will provide you with years of rot-free and worry-free performance. Enhance your home's look with various trim profile options.

Choose from four frame options to complete your entry door.



DURA-FRAME™ JAMB

- Primed wood jamb
- Alaskan Yellow Cypress finger jointed to the ends
- Resists moisture, rot and insects
- One-piece design, up to 12" depth



DURA-TECH JAMB

- Durable PVC bonded to the Dura-Frame™ jamb
- Paint and stain options
- Includes matching brickmold that's splined for nail-free attachment



STEEL FRAME

- Ideal for light commercial applications
- Easy installation; accommodates varying wall thicknesses
- Can be installed after walls and flooring are finished
- 90-minute fire rating
- White frame is paintable after installation
- Optional steel casing



CLAD FRAME

- Durable .092" thick extruded aluminum cladding
- Built on Dura-Frame™
- Powder-coated finish provides exceptional color retention

Refer to the next page for trim and color options.



CLAD FRAME - TRIM OPTIONS



BRICKMOLD



MODERN NOSING



ACCESSORY BRICKMOLD



NARROWLINE NOSING

CLAD FRAME - COLORS



NOTE: Colors shown are as accurate as printing technologies allow; refer to the color fan deck for accurate color.

Select Your Hardware

Your front door is more than just a secured entrance, it's also a showpiece. Our handle selections and hardware finishes provide your home's style with just the right touch.

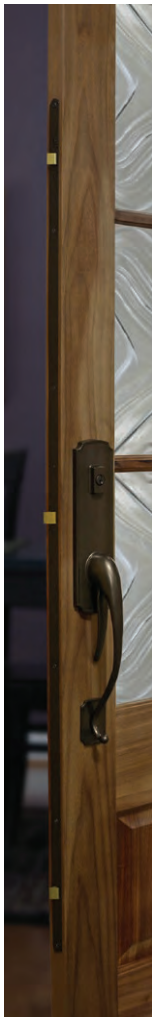

TRILENNIUM® MULTI-POINT LOCKING SYSTEM

RELIABLE SECURITY

Operating as one, all three bolts engage when the door is closed. One movement of the thumbturn or key activates all three deadbolts. When activated, each bolt becomes a deadbolt that cannot be compromised.

PEACE OF MIND

Delivers the strength of one solid locking unit combined with the protection of three deadbolts.

PANIC RELEASE

A single downward turn of the interior handle releases all three deadbolts.

FORGIVING WHEN INSTALLED

You can't control the rough opening, or what happens over time. Trilennium can correct door misalignment up to 3/16", so it works when others don't.

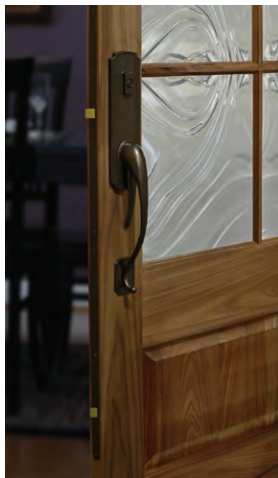

TRILENNIUM® HANDLESETS



ECLIPSE



PINNACLE



RECTANGULAR



CURVED



HORIZON



ECLIPSE GRIP

TRILENNIUM® FINISHES



VICTORIAN BRONZE



BRIGHT BRASS



SATIN NICKEL



BLACK

SCHLAGE® FINISHES



MATTE BLACK AGED BRONZE SATIN NICKEL BRIGHT CHROME ANTIQUE BRASS BRIGHT BRASS

SCHLAGE® DEADBOLTS



DEADBOLT CAMELOT DEADBOLT CENTURY DEADBOLT ADDISON DEADBOLT

SCHLAGE® LOCKS Keyed or non-keyed

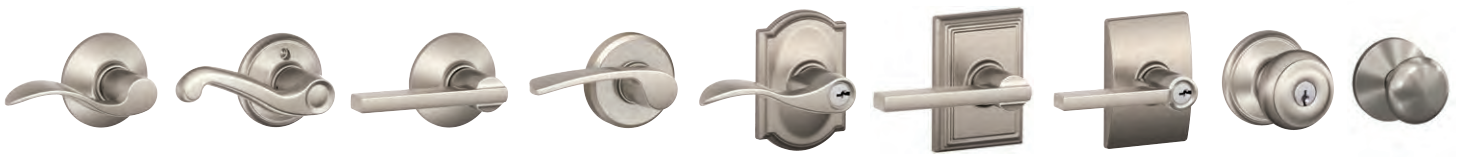

ACCENT LEVER FLAIR LEVER LATITUDE LEVER MERANO LEVER ACCENT LEVER, CAMELOT TRIM LATITUDE LEVER, ADDISON TRIM LATITUDE LEVER, CENTURY TRIM GEORGIAN KNOB PLYMOUTH KNOB

SCHLAGE® HANDLESETS



CAMELOT HANDLESET & INSIDE ACCENT LEVER WITH CAMELOT TRIM CENTURY HANDLESET & INSIDE LATITUDE LEVER WITH CENTURY TRIM ADDISON HANDLESET & INSIDE LATITUDE LEVER WITH ADDISON TRIM PLYMOUTH HANDLESET

INSIDE TRIM OPTIONS

Pair with any handleset



LATITUDE LEVER ACCENT LEVER GEORGIAN KNOB
MERANO LEVER FLAIR LEVER PLYMOUTH KNOB

ELECTRONIC DEADBOLTS WITH HANDLESETS



CENTURY KEYLESS TOUCHSCREEN DEADBOLT



CAMELOT KEYLESS TOUCHSCREEN DEADBOLT



CAMELOT KEYPAD DEADBOLT

Pair with Century electronic deadbolt



LATITUDE LEVER, CENTURY TRIM

LOWER HANDLESET & INSIDE LATITUDE LEVER WITH CENTURY TRIM

Pair with Camelot electronic deadbolt

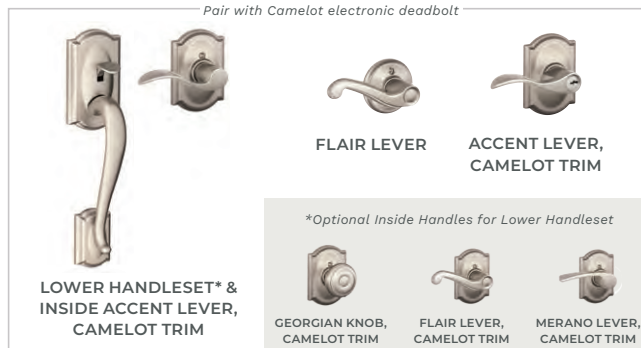

LOWER HANDLESET* & INSIDE ACCENT LEVER, CAMELOT TRIM

FLAIR LEVER ACCENT LEVER, CAMELOT TRIM

**Optional Inside Handles for Lower Handleset*



GEORGIAN KNOB, CAMELOT TRIM FLAIR LEVER, CAMELOT TRIM MERANO LEVER, CAMELOT TRIM

Pair with any electronic deadbolt



LATITUDE LEVER
ACCENT LEVER
GEORGIAN KNOB

Discover Your Color

Color has the power to transform the look of your home. It can set the mood, create space and even boost the value of your home. Choose a color that stands out but still complements your home's color palette.



A Pop of Color

Add major visual interest with an eye-catching front door. A splash of yellow or orange makes a bright statement. Alternatively, you can choose to go bold with a deep shade of red or purple.



Custom Color

**CHOOSE A COLOR
that is authentically you.**

Fall in love with your home again. You're an out-of-the-box kind of thinker and we want you to have the freedom to do so.

Sample size must be 2" x 2" minimum for an accurate color match. Work with your dealer or contractor to start the custom color process.

Custom colors are available for
paint finishes and clad frames.

Color Collections

Our color collections are all about expressing your personality and creating a home that is a true representation of those who live inside it. From bold and energetic, to neutral and serene, we have a color for everyone.



Forever Home

A reflection of your inner world.
Make it sacred and beautiful.

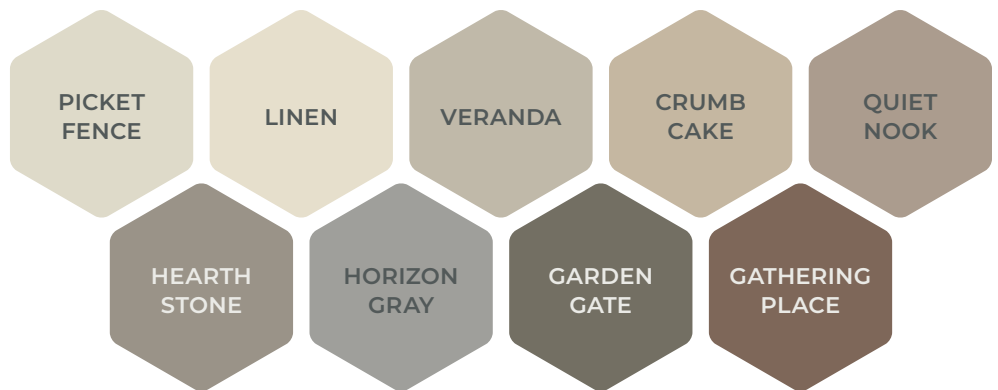

Stately Retreat

Where luxury meets sophistication.
Timeless and full of elegance.



Treasured Legacy

Where memories are made and cherished for years to come.



Retro Revival

Home is where stories of yesterday meet the dreams of tomorrow.



Cozy Cottage

Home should be warm, relaxing, full of charm and character.



Woodgrain Finishes

Woodgrain doors are the perfect solution for achieving the richness and beauty of wood without the maintenance. The richness of wood helps to create a stunning first impression and instant curb appeal.

Colors are available on wood textured door series:
Norwood Steel, Timberline Fiberglass, and Timbergrain Fiberglass.



NOTE: Colors shown are as accurate as printing technologies allow. Swatches shown on Timbergrain Fiberglass in Cherry.

Home is an expression of who you are.
Choose a *color* that is authentically you.



MIX & MATCH

Complement both exterior and interior color palettes by choosing a different color for the exterior and interior side of your door.



ELEVATE YOUR EXTERIOR

When choosing your front door color, find those that blend with or complement the fixed features, such as the walkway and stone/brick accents.



Swing Options

A well-designed front entry door can provide curb appeal and add value to any home. Choose between an inswing or outswing, single door or double door, and whether you want sidelites or an overhead transom.

SINGLE DOOR INSWING



Hinge Left
Right Hand

Hinge Right
Left Hand

SINGLE DOOR OUTSWING



Hinge Left
Right Hand

Hinge Right
Left Hand

PANEL & FIXED SIDELITE INSWING



Hinge Left
Right Hand

Hinge Right
Left Hand

PANEL & FIXED SIDELITE OUTSWING



Hinge Left
Right Hand

Hinge Right
Left Hand

PANEL & TWO FIXED SIDELITES INSWING



Hinge Left
Right Hand

Hinge Right
Left Hand

PANEL & TWO FIXED SIDELITES OUTSWING



Hinge Left
Right Hand

Hinge Right
Left Hand



**DOUBLE DOOR
INSWING**



Hinge Left
Right Hand

Hinge Right
Left Hand

**DOUBLE DOOR
OUTSWING**



Hinge Left
Right Hand

Hinge Right
Left Hand

**DOUBLE DOOR WITH FIXED SIDELITE
INSWING**



Hinge Left
Right Hand

Hinge Right
Left Hand

**DOUBLE DOOR WITH FIXED SIDELITE
OUTSWING**



Hinge Left
Right Hand

Hinge Right
Left Hand

**DOUBLE DOOR WITH TWO FIXED SIDELITES
INSWING**



Hinge Left
Right Hand

Hinge Right
Left Hand

**DOUBLE DOOR WITH TWO FIXED SIDELITES
OUTSWING**



Hinge Left
Right Hand

Hinge Right
Left Hand

NOTE: Viewed from exterior.

Swing Options

A well-designed front entry door can provide curb appeal and add value to any home. Choose between a single door or double door, and whether you want sidelites or an overhead transom.

PATIO/SINGLE SWING DOUBLE DOOR CENTER HINGED - INSWING



XO (operable-fixed),
HLIS)

OX (fixed-operable,
HRIS)

PATIO/SINGLE SWING DOUBLE DOOR CENTER HINGED - OUTSWING



OX (fixed-operable,
HLOS)

XO (operable-fixed),
HROS)

PATIO/SINGLE SWING DOUBLE DOOR JAMB HINGED - INSWING



OX (fixed-operable,
HLIS)

XO (operable-fixed),
HRIS)

PATIO/SINGLE SWING DOUBLE DOOR JAMB HINGED - OUTSWING



XO (operable-fixed),
HLOS)

OX (fixed-operable,
HROS)

PATIO/SINGLE SWING DOUBLE DOOR WITH TWO FIXED SIDELITES - JAMB HINGED - INSWING



SOXS (Sidelite-Fixed-Operable-Sidelite, HLIS)

SXOS (Sidelite-Operable-Fixed-Sidelite, HRIS)

PATIO/SINGLE SWING DOUBLE DOOR WITH TWO FIXED SIDELITES - JAMB HINGED - OUTSWING



SXOS (Sidelite-Operable-Fixed-Sidelite, HLOS)

SOXS (Sidelite-Fixed-Operable-Sidelite, HROS)

Opening Specifications

NEW CONSTRUCTION UNITS – Wood and Extruded Aluminum Clad Frames (Inswing)								
DESCRIPTION	Actual Frame Width Size	Stud-to-Stud Rough Opening Minimum	Width Dimension (Outside Brickmold)	Width Dimension (Outside Modern Nosing)				
Opening Dimensions for Single, Double & Patio Doors								
2'6" Single Door	31-1/2"	32-1/2"	34"	32-5/8"				
2'8" Single Door	33-1/2"	34-1/2"	36"	34-5/8"				
2'10" Single Door	35-1/2"	36-1/2"	38"	36-5/8"				
3'0" Single Door	37-1/2"	38-1/2"	40"	38-5/8"				
3'6" Single Door	43-1/2"	44-1/2"	46"	44-5/8"				
4'0" Single Door	49-1/2"	50-1/2"	52"	50-5/8"				
5'0" Double Door	62"	63"	64-1/2"	63-1/8"				
5'4" Double Door	66"	67"	68-1/2"	67-1/8"				
5'4" Patio Door	67"	68"	69-1/2"	68-1/8"				
6'0" Double Door	74"	75"	76-1/2"	75-1/8"				
6'0" Patio Door	75"	76"	77-1/2"	76-1/8"				
Opening Dimensions for Door(s) with Fixed Sidelites or Direct Set Glass (Inswing)								
Sidelite Size	12"	14"	12"	14"	12"	14"	12"	14"
2'6" Single Door w/ 1 Sidelite	45"	47"	46"	48"	47-1/2"	49-1/2"	46-1/8"	48-1/8"
2'8" Single Door w/ 1 Sidelite	47"	49"	48"	50"	49-1/2"	51-1/2"	48-1/8"	50-1/8"
2'10" Single Door w/ 1 Sidelite	49"	51"	50"	52"	51-1/2"	53-1/2"	50-1/8"	52-1/8"
3'0" Single Door w/ 1 Sidelite	51"	53"	52"	54"	53-1/2"	55-1/2"	52-1/8"	54-1/8"
5'4" Double Door w/ 1 Sidelite	79-1/2"	81-1/2"	80-1/2"	82-1/2"	82"	84"	80-5/8"	82-5/8"
6'0" Double Door w/ 1 Sidelite	87-1/2"	89-1/2"	88-1/2"	90-1/2"	90"	92"	88-5/8"	90-5/8"
2'6" Single Door w/ 2 Sidelites	58-1/2"	62-1/2"	59-1/2"	63-1/2"	61"	65"	59-5/8"	63-5/8"
2'8" Single Door w/ 2 Sidelites	60-1/2"	64-1/2"	61-1/2"	65-1/2"	63"	67"	61-5/8"	65-5/8"
2'10" Single Door w/ 2 Sidelites	62-1/2"	66-1/2"	63-1/2"	67-1/2"	65"	69"	63-5/8"	67-5/8"
3'0" Single Door w/ 2 Sidelites	64-1/2"	68-1/2"	65-1/2"	69-1/2"	67"	71"	65-5/8"	69-5/8"
5'4" Double Door w/ 2 Sidelites	93"	97"	94"	98"	95-1/2"	99-1/2"	94-1/8"	98-1/8"
6'0" Double Door w/ 2 Sidelites	101"	105"	102"	106"	103-1/2"	107-1/2"	102-1/8"	106-1/8"

Actual Frame Height / UDH (Rough Opening Height)		
6'8"	7'0"	8'0"
Units with Standard Sill		
81-3/4" UDH (82" RO) Inswing	85-3/4" UDH (86" RO) Inswing	97-3/4" UDH (98" RO) Inswing
81-1/4" UDH (81-1/2" RO) Outswing	85-1/4" UDH (85-1/2" RO) Outswing	97-1/4" UDH (97-1/2" RO) Outswing
Units with ADA Sill		
80-3/4" UDH (81" RO) Inswing or Outswing	84-3/4" UDH (85" RO) Inswing or Outswing	96-3/4" UDH (97" RO) Inswing or Outswing
81" UDH (81-1/4" RO) Clad Outswing	85" UDH (85-1/4" RO) Clad Outswing	97" UDH (97-1/4" RO) Clad Outswing

NOTES:
 Outside brickmold height is 1" more than RO height.
 Outside Modern nosing height is 9/16" more than RO height.
 Outside Narrowline nosing is equal to unit dimension.

NOTE: For single clad outswing units, add 1/4" to the UDW shown above.
 For double doors that are both clad and outswing, add 3/8" to the UDW shown above.
 For primed wood outswing units, add 5/8" to outside brickmold width.
 For steel frames, add 1" to nominal width and 1/2" to nominal height for rough opening.

For sidelite units that are both clad and outswing, add 1/4" to the UDW shown above.
 For double doors that have wood jambs but are also outswing, add 1/8" to UDW shown above.
 For masonry construction, add 1/4" to outside brickmold dimension shown.

REPLACEMENT (REMODELER) UNITS

OPENING DIMENSIONS FOR SINGLE REMODELER UNITS

Size (nominal)	Fits these existing openings			
	'A' Widths		'B', 'C' Heights	
	Min.	Max.	Min.	Max.
2'5" x 6'7" Single Door	29-5/8"	30-1/2"	80"	80-1/2"
2'7" x 6'7" Single Door	31-5/8"	32-1/2"	80"	80-1/2"
2'9" x 6'7" Single Door	33-5/8"	34-1/2"	80"	80-1/2"
2'11" x 6'7" Single Door	35-5/8"	36-1/2"	80"	80-1/2"

TRANSOM ROUGH OPENINGS

Sizes for 6'8" Doors	Transom Type	Rough Opening Widths	Rough Opening Heights	Unit Size
Rough Opening (stud to stud) for inswing & outswing doors	TR-98	see above chart	102-5/8"	102-3/8"
	TR-97		102-5/8"	102-3/8"
	TR-92		102-5/8"	102-3/8"
	TR-89/90/94		97-3/4"	97-1/4"
	TR-96/99		93-3/4"	93-1/4"
	TR-91		93-3/4"	93-1/4"
	TR-95		varies	varies
	TR-93		varies	varies

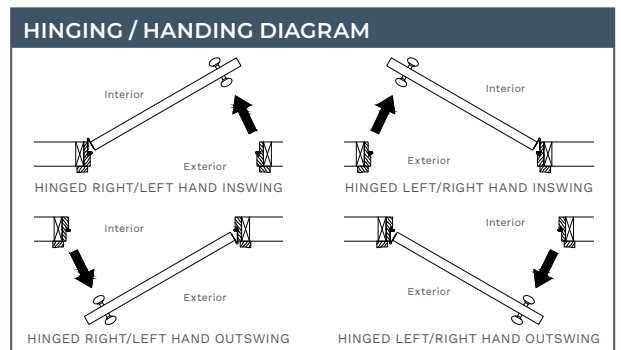

NOTE: For 6'11" heights, ADD 4" to rough openings shown.
 We reserve the right, without notice, to make changes in specifications, construction, design, details, and pricing at any time in such a manner as we may consider necessary or advisable. Corrections to reflect any such changes shall be included in subsequent printings of this publication.

NORANDEX
MAXIMA[®]
Advantage



**SURROUNDED
BY QUALITY**



**BUILT FOR
LONG-TERM
PERFORMANCE**



**KEEP YOUR
FAMILY SAFE**



**SELECTION FOR
EVERY STYLE**



**COMPLEMENT YOUR NEW ENTRY SYSTEM
WITH OTHER QUALITY EXTERIOR PRODUCTS**

Your home deserves the best. That's why, in addition to entry doors, we offer other top quality products to beautify and protect your home. Whether it's vinyl siding, energy-efficient windows, soffit, trim, or metals, you can rest comfortably knowing you've finished your home with performance products that are among the best the industry has to offer.



1-800-528-0942
www.norandex.com